

**ARMY TM 5-8204
AIR FORCE AFM 885, chap 4**

TECHNICAL MANUAL

DRAINAGE FOR AREAS OTHER THAN AIRFIELDS

This copy is a reprint which includes current pages from Change 1.

DEPARTMENTS OF THE ARMY AND THE AIR FORCE

OCTOBER 1983

REPRODUCTION AUTHORIZATION/RESTRICTIONS

This manual has been prepared by or for the Government and is public property and not subject to copyright.

Reprints or republications of this manual should include a credit substantially as follows: "Joint Departments of the Army and Air Force, USA, Technical Manual TM 5-820-AFM 88-5, Chapter 4, Drainage for Areas Other Than Airfields, date."

Change

DEPARTMENTS OF THE ARMY,
AND THE AIR FORCE

No. 1

Washington, DC 16 July 1985

DRAINAGE FOR AREAS OTHER THAN AIRFIELDS

TM 5-820-4/AFM 88-5, Chapter 4, 14 October 1983, is changed as follows:

1. Remove old pages and insert new pages as indicated below. New or changed material is indicated by a vertical bar in the margin of the page.

Remove pages

Insert pages

| | |
|--------------------|-------------------|
| i and ii..... | i and ii |
| 3-7 and 3-8..... | 3-7 and 3-8 |
| A-1 and A-2..... | A-1 through A-3 |
| B-31 and B-32..... | B-31 and B-32 |
| C-3 and C-4..... | C-3 and C-4 |
| C-9..... | C-9 through C-12a |

2. File this change sheet in front of the publication for reference purposes.

By Order of the Secretaries of the Army and the Air Force

JOHN A. WICKHAM, JR.
General, United States Army
Chief of Staff

Official: _____

DONALD J. DELANDRO
Brigadier General, United States Army
The Adjutant General

CHARLES A. GABRIEL
General, United States Air Force
Chief of Staff

Official: _____

JAMES H. DELANEY
Colonel, United States Air Force
Director of Administration

DISTRIBUTION:

To be distributed in accordance with DA Form 12-34B requirements for TM 5-800 Series: Engineering
and Design for Real Property Facilities.

DRAINAGE FOR AREAS OTHER THAN AIRFIELDS

| | | Paragraph | Page |
|-------------|--|-----------|------|
| CHAPTER 1. | INTRODUCTION | | |
| | Purpose and scope..... | 1-1 | 1-1 |
| | General investigations..... | 1-2 | 1-1 |
| | Environmental considerations..... | 1-3 | 1-1 |
| 2. | HYDROLOGY | | |
| | General..... | 2-1 | 2-1 |
| | Design storm..... | 2-2 | 2-1 |
| | Infiltration and other losses..... | 2-2 | 2-1 |
| | Runoff computations..... | 2-4 | 2-2 |
| 3. | HYDRAULICS | | |
| | General..... | 3-1 | 3-1 |
| | Channels..... | 3-2 | 3-1 |
| | Bridges..... | 3-3 | 3-4 |
| | Curb-and-gutter sections..... | 3-4 | 3-5 |
| | Culverts..... | 3-5 | 3-5 |
| | Underground hydraulic design..... | 3-6 | 3-9 |
| | Inlets..... | 3-7 | 3-9 |
| | Veicular safety and hydraulically efficient drainage practice..... | 3-8 | 3-17 |
| 4. | HYDRAULIC STRUCTURES | | |
| | Manholes and junction boxes..... | 4-1 | 4-1 |
| | Detention pond storage..... | 4-2 | 4-1 |
| | Outlet energy dissipators..... | 4-3 | 4-1 |
| | Drop structures and check dams..... | 4-4 | 4-5 |
| | Miscellaneous structures..... | 4-5 | 4-5 |
| 5. | EROSION CONTROL AND RIPRAP PROTECTION | | |
| | General..... | 5-1 | 5-1 |
| | Riprap protection..... | 5-2 | 5-1 |
| | Selection of stone size..... | 5-3 | 5-1 |
| | Riprap gradation..... | 5-4 | 5-2 |
| | Riprap design..... | 5-5 | 5-2 |
| 6. | SUBSURFACE DRAINAGE | | |
| | General..... | 6-1 | 6-1 |
| | Subsurface drainage requirements..... | 6-2 | 6-1 |
| | Laboratory tests..... | 6-3 | 6-1 |
| | Flow of water through soils..... | 6-4 | 6-1 |
| | Drainage of water from soil..... | 6-5 | 6-2 |
| | Backfill for subsurface drains..... | 6-6 | 6-2 |
| APPENDIX A. | REFERENCES..... | | A-1 |
| B. | HYDRAULIC DESIGN DATA FOR CULVERTS..... | | B-1 |
| C. | PIPE STRENGTH, COVER AND BEDDING..... | | C-1 |
| D. | NOTATION..... | | D-1 |
| E. | BIBLIOGRAPHY..... | | E-1 |

LIST OF FIGURES

| | | Page |
|------------|--|------|
| Figure 3-1 | Superelevation formulas..... | 3-3 |
| 3-2 | Nomograph for flow in triangular channels..... | 3-6 |
| 3-3 | Capacity of grate inlet in sump water pond on grate..... | 3-11 |
| 3-4 | Capacity of curb opening inlet at low point in grade..... | 3-12 |
| 3-5 | Standard type "A" and type "B" inlets..... | 3-14 |
| 3-6 | Type "C" inlet—square grating..... | 3-15 |
| 3-7 | Standard type "D" inlet..... | 3-16 |
| 4-1 | Standard storm drain manhole..... | 4-2 |
| 4-2 | Standard precast manholes..... | 4-3 |
| 4-3 | Junction details for large pipes..... | 4-4 |
| 4-4 | Outlet security barrier..... | 4-6 |
| B-1 | Inlet control..... | B-2 |
| B-2 | Headwater depth for concrete pipe culverts with inlet control..... | B-3 |
| B-3 | Headwater depth for oval concrete pipe culverts long axis vertical with inlet control..... | B-4 |
| B-4 | Headwater depth for oval concrete pipe culverts long axis horizontal with inlet control..... | B-5 |

*This manual supersedes TM 5-820-4/AFM 86-5, Chap 4, 14 August 1964

| | <u>Page</u> |
|----------------|---|
| Figure No. B-5 | Headwater depth for corrugated metal pipe culverts with inlet control..... B-6 |
| B-6 | Headwater depth for structural plate and standard corrugated metal pipe-arch culverts with inlet control..... B-7 |
| B-7 | Headwater depth for box culverts with inlet control..... B-8 |
| B-8 | Headwater depth for corrugated metal pipe culverts with tapered inlet-inlet control..... B-9 |
| B-9 | Headwater depth for circular pipe culverts with beveled ring inlet control..... B-10 |
| B-10 | Outlet control..... B-11 |
| B-11 | Head for circular pipe culverts flowing full, n = 0.012..... B-13 |
| B-12 | Head for oval circular pipe culverts long axis horizontal or vertical flowing full, n = 0.012..... B-14 |
| B-13 | Head for circular pipe culverts flowing full, n = 0.024..... B-15 |
| B-14 | Head for circular pipe culverts flowing full, n = 0.0328 to 0.0302..... B-16 |
| B-15 | Head for standard corrugated metal pipe-arch culverts flowing full, n = 0.024..... B-17 |
| B-16 | Head for field-bolted structural plate pipe-arch culverts 18 in. corner radius flowing full, n = 0.0327 to 0.0306..... B-18 |
| B-17 | Head for concrete box culverts flowing full, n = 0.012..... B-19 |
| B-18 | Tailwater elevation at or above top of culvert..... B-21 |
| B-19 | Tailwater below the top of the culvert..... B-22 |
| B-20 | Circular pipe—critical depth..... B-24 |
| B-21 | Oval concrete pipe long axis horizontal critical depth..... B-25 |
| B-22 | Oval concrete pipe long axis vertical critical depth..... B-26 |
| B-23 | Standard corrugated metal pipe-arch critical depth..... B-27 |
| B-24 | Structural plate pipe-arch critical depth..... B-28 |
| B-25 | Critical depth rectangular section..... B-29 |
| B-26 | Culvert capacity circular concrete pipe groove-edged entrance 18" to 66"..... B-32 |
| B-27 | Culvert capacity circular concrete pipe groove-edged entrance 60" to 180"..... B-33 |
| B-28 | Culvert capacity standard circular corrugations metal pipe projecting entrance 18" to 36"..... B-34 |
| B-29 | Culvert capacity standard circular corrugations metal projecting entrance 36" to 66"..... B-35 |
| B-30 | Culvert capacity standard circular corrugations metal headwall entrance 18" to 36"..... B-36 |
| B-31 | Culvert capacity standard circular corrugations metal headwall entrance 36" to 66"..... B-37 |
| B-32 | Culvert capacity standard corrugations metal pipe-arch projecting entrance 25' x 16" to 43' x 27"..... B-38 |
| B-33 | Culvert capacity standard corrugations metal pipe-arch projecting entrance 50" x 31" to 72" x 44"..... B-39 |
| B-34 | Culvert capacity standard corrugations metal pipe-arch headwall entrance 25' x 16" to 43' x 27"..... B-40 |
| B-35 | Culvert capacity standard corrugations metal pipe-arch headwall entrance 50" x 31" to 72" x 44"..... B-41 |
| B-36 | Culvert capacity square concrete box 90° and 15° wingwall flare 1.5' x 1.5' to 7' x 7'..... B-42 |
| B-37 | Culvert capacity square concrete box 30° to 75° wingwall flare 1.5' x 1.5' to 7' x 7'..... B-43 |
| B-38 | Culvert capacity rectangular concrete box 90° and 15° wingwall flare 1.5', 2.0' and 2.5' heights..... B-44 |
| B-39 | Culvert capacity rectangular concrete box 90° and 15° wingwall flare 3' and 4' heights..... B-45 |
| B-40 | Culvert capacity rectangular concrete box 90° and 15° wingwall flare 5' and 6' heights..... B-46 |
| B-41 | Culvert capacity rectangular concrete box 30° to 75° wingwall flare 1.5', 2.0' and 2.5' heights..... B-47 |
| B-42 | Culvert capacity rectangular concrete box 30° to 75° wingwall flare 3' and 4' heights..... B-48 |
| B-43 | Culvert capacity rectangular concrete box 30° to 75° wingwall flare 5' and 6' heights..... B-49 |
| C-1 | Three main classes of conduits..... C-8 |
| C-2 | Free-body conduit diagrams..... C-9 |
| ■ C-3 | Embankment beddings circular pipe..... C-10 |
| ■ C-4 | Trench beddings for circular pipe..... C-11 |
| ■ C-5 | Flexible pipe bedding and installation..... C-12 |
| ■ C-6 | Beddings for positive projecting conduits..... C-12a |

LIST OF TABLES

| <u>Table</u> | <u>Page</u> |
|--------------|---|
| 2-1 | Typical Values of Infiltration Rates..... 2-2 |
| 4-1 | Maximum Permissible Mean Velocities to Prevent Scour..... 4-1 |
| B-1 | Entrance Loss Coefficients..... B-12 |
| B-2 | Manning's n for Natural Stream Channels..... B-20 |
| B-3 | Roughness Coefficients for Various Pipes..... B-31 |
| C-1 | Suggested Maximum Cover Requirements for Asbestos-Cement Pipe..... C-2 |
| C-2 | Suggested Maximum Cover Requirements for Concrete Pipe..... C-3 |
| C-3 | Suggested Maximum Cover Requirements for Corrugated-Aluminum-Alloy Pipe, Riveted, Helical, or Welded Fabrication, 2 3/8 Inch Spacing, 1/2-Inch Deep Corrugations..... C-4 |
| C-4 | Suggested Maximum Cover Requirements for Corrugated-Steel-Pipe, 2 3/8 Inch Spacing, 1/2-Inch Deep Corrugations..... C-5 |
| C-5 | Suggested Maximum Cover Requirements for Structural-Plate-Aluminum-Alloy Pipe, 9-Inch Spacing, 2 1/2-Inch Corrugations..... C-6 |
| C-6 | Suggested Maximum Cover Requirements for Corrugated Steel Pipe, 125 mm Span, 25 mm Corrugations..... C-7 |
| C-7 | Suggested Maximum Cover Requirements for Structural Plate Steel Pipe, 6-Inch Span, 2-Inch Deep Corrugations..... C-13 |
| C-8 | Suggested Maximum Cover Requirements for Corrugated Steel Pipe, 3-Inch Span, 1-Inch Corrugations..... C-14 |
| C-9 | Suggested Guidelines for Minimum Cover..... C-16 |

CHAPTER 1

INTRODUCTION

1-1. Purpose and scope. The purpose of this manual is to discuss normal requirements for design of surface and subsurface drainage systems for military construction other than airfields and heliports at Army, Air Force and similar installations. Sound engineering practice should be followed when unusual or special requirements not covered by these instructions are encountered.

1-2. General investigations. An on-site investigation of the system site and tributary area is a prerequisite for study of drainage requirements. Information regarding capacity, elevations, and condition of existing drains will be obtained. Topography, size and shape of drainage area, and extent and type of development; profiles, cross sections, and roughness data on pertinent existing streams and watercourses; and location of possible ponding areas will be determined. Thorough knowledge of climatic conditions and precipitation characteristics is essential. Adequate information regarding soil conditions, including types, permeability on perviousness, vegetative cover, depth to and movement of subsurface water, and depth of frost will be secured. outfall and downstream flow conditions, including high-water occurrences and frequencies, also must be determined. Effect of base drainage construction on local interests' facilities and local requirements that will affect the design of the drainage works will be evaluated. Where diversion of runoff is proposed, particular effort will be made to avoid resultant

downstream conditions leading to unfavorable public relations, costly litigations, or damage claims. Any agreements needed to obtain drainage easements and/or avoid interference with water rights will be determined at the time of design and consummated prior to initiation of construction. Possible adverse effects on water quality due to disposal of drainage in waterways involved in water-supply systems will be evaluated.

1-3. Environmental considerations.

a. Surface drainage systems have either beneficial or adverse environmental impacts affecting water, land, ecology, and socio-economic considerations. Effects on surrounding land and vegetation may cause changes in various conditions in the existing environment, such as surface water quantity and quality, groundwater levels and quality, drainage areas, animal and aquatic life, and land use. Environmental attributes related to water could include such items as erosion, flood potential, flow variations, biochemical oxygen demand, content of dissolved solids, nutrients and coliform organisms. These are among many possible attributes to be considered in evaluating environmental impacts, both beneficial and adverse, including effects on surface water and groundwater.

b. Federal agencies shall initiate measures to direct their policies, plans, and programs so as to meet national environmental goals and standards.

CHAPTER 2

HYDROLOGY

2-1. General. Hydrologic studies include a careful appraisal of factors affecting storm runoff to insure the development of a drainage system or control works capable of providing the required degree of protection. The selection of design storm magnitudes depends not only on the protection sought but also on the type of construction contemplated and the consequences of storms of greater magnitude than the design storm. Ground conditions affecting runoff must be selected to be consistent with existing and anticipated areal development and also with the characteristics and seasonal time of occurrence of the design rainfall. For areas of up to about 1 square mile, where only peak discharges are required for design and extensive ponding is not involved, computation of runoff will normally be accomplished by the so-called Rational Method. For larger areas, when suitable unit-hydrograph data are available or where detailed consideration of ponding is required, computation should be by unit-hydrograph and flow-routing procedures.

2-2. Design storm.

a. For such developed portions of military installations as administrative, industrial, and housing areas, the design storm will normally be based on rainfall of 10-year frequency. Potential damage or operational requirements may warrant a more severe criterion; in certain storage and recreational areas a lesser criterion may be appropriate. (With concurrence of the using Service, a lesser criterion may also be employed in regions where storms of an appreciable magnitude are infrequent and either damages or operational capabilities are such that large expenditures for drainage are not justified.)

b. The design of roadway culverts will normally be based on 10-year rainfall. Examples of conditions where greater than 10-year rainfall may be used are areas of steep slope in which overflows would cause severe erosion damage; high road fills that impound large quantities of water; and primary diversion structures, important bridges, and critical facilities where uninterrupted operation is imperative.

c. Protection of military installations against floodflows originating from areas exterior to the installation will normally be based on 25-year or greater rainfall, again depending on operational requirements, cost-benefit considerations, and nature and consequences of flood damage resulting from the failure of protective works. Justification for the selected design storm will be presented, and, if appropriate, comparative costs and damages for alternative designs should be included.

d. Rainfall intensity will be determined from the best available intensity-duration-frequency data. Basic information of this type will be taken from such publications as (see app A for referenced publications);

Rainfall Frequency Atlas of the United States. Technical Paper No. 40.

Generalized Estimates of Probable Maximum Precipitation and Rainfall-Frequency Data for Puerto Rico and Virgin Islands. Technical Paper No. 42.

Rainfall-Frequency Atlas of the Hawaiian Islands. Technical Paper No. 43.

Probable Maximum Precipitation and Rainfall Frequency Data for Alaska. Technical Paper No. 47.

TM 5-785/AFM 88-29/NAVFAC P-89.

These publications may be supplemented as appropriate by more detailed publications of the Environmental Data and Information Center and by studies of local rainfall records. For large areas and in studies involving unit hydrography and flow-routing procedures, appropriate design storms must be synthesized from areal and time-distribution characteristics of typical regional rainfalls.

e. For some areas, it might reasonably be assumed that the ground would be covered with snow when the design rainfall occurs. If so, snowmelt would add to the runoff. Detailed procedures for estimating snowmelt runoff are given in TM 5-852-7/AFM 88-19, Chap 7. It should be noted, however, that the rate of snowmelt under the range of hydro-meteorological conditions normally encountered in military drainage design would sel-

dom exceed 0.2 inches per hour and could be substantially less than that rate.

f. In selecting the design storm and making other design decisions, particular attention must be given to the hazard to life and other disastrous consequences resulting from the failure of protective works during a great flood. Potentially hazardous situations must be brought to the attention of the using service and others concerned so that appropriate steps can be taken.

2-3. Infiltration and other losses.

a. Principal factors affecting the computation of runoff from rainfall for the design of military drainage systems comprise initial losses, infiltration, transitory storage, and, in some areas, percolation into natural streambeds. If necessary data are available, an excellent indication of the magnitudes of these factors can be derived from thorough analysis of past storms and recorded flows by the unit-hydrograph approach. At the onset of a storm, some rainfall is effectively retained in "wetting down" vegetation and other surfaces, in satisfying soil moisture deficiencies, and in filling surface depressions. Retention capacities vary considerably according to surface, soil type, cover, and antecedent moisture conditions. For high intensity design storms of the convective, thunderstorm type, a maximum initial loss of up to 1 inch may be assumed for the first hour of storm precipitation, but the usual values are in the range of 0.25 to 0.50 inches per hour. If the design rainfall intensity is expected to occur during a storm of long duration, after substantial amounts of immediately prior rain, the retention capacity would have been satisfied by the prior rain and no further assumption of loss should be made.

b. Infiltration rates depend on type of soils, vegetal cover, and the use to which the areas are subjected. Also, the rates decrease as the duration of rainfall increases. Typical values of infiltration for generalized soil classifications are shown in table 2-1. The soil group symbols are those given in MIL-STD-619, Unified Soil Classification System for Roads, Airfields, Embankments, and Foundations. These infiltration rates are for uncompacted soils. Studies indicate that compacted soils decrease infiltration values from 25 to 75 percent, the difference depending on the degree of compaction and the soil type. Vegetation generally decreases the infiltration capacity of coarse soils and increases that of clayey soils.

c. Peak rates of runoff are reduced by the effect of transitory storage in watercourses and minor

Table 2-1. Typical Values of Infiltration Rates

| Description | Soil group symbol | Infiltration, inches/hour |
|---|------------------------|---------------------------|
| Sand and gravel mixture | GW, GP SW, SP | 0.8-1.0 |
| Silty gravels and silty sands to inorganic silt, and well-developed loams | GM, SM ML, MH OL | 0.3-0.6 |
| Silty clay sand to sandy clay | SC, CL | 0.2-0.3 |
| Clays, inorganic and organic | CH, OH | 0.1-0.2 |
| Bare rock, not highly fractured | ----- | 0.0-0.1 |

U.S. Army Corps of Engineers

ponds along the drainage route. The effects are reflected in the C factor of the Rational Formula (given below) or in the shape of the unit hydrograph. Flow-routing techniques must be used to predict major storage effects caused by natural topography or man-made developments in the area.

d. Streambed percolation losses to direct runoff need to be considered only for sandy, alluvial watercourses, such as those found in arid and semi-arid regions. Rates of streambed percolation commonly range from 0.15 to 0.5 cubic feet per second per acre of wetted area.

2-4. Runoff computations.

a. Design procedures for drainage facilities involve computations to convert rainfall intensities expected during the design storm into runoff rates which can be used to size the various elements of the storm drainage system. There are two basic approaches: first, direct estimates of the proportion of average rainfall intensity that will appear as the peak runoff rate; and, second, hydrography methods that depict the time-distribution of runoff events after accounting for losses and attenuation of the flow over the surface to the point of design. The first approach is exemplified by the Rational Method which is used in the large majority of engineering offices in the United States. It can be employed successfully and consistently by experienced designers for drainage areas up to 1 square mile in size. *Design and Construction of Sanitary and Storm Sewers*, ASCE Manual No. 37, and *Airport Drainage*, FAA AC 150/5320-5B, explain and illustrate use of the method. A modified method is outlined below. The second approach encompasses the analysis of unit-hydrograph techniques to synthesize complete runoff hydrography.

b. To compute peak runoff the empirical formula $Q=C(1-F)A$ can be used; the terms are defined

in appendix D. This equation is known as the modified rational method.

(1) *C* is a coefficient expressing the percentage to which the peak runoff is reduced by losses (other than infiltration) and by attenuation owing to transitory storage. Its value depends primarily on surface slopes and irregularities of the tributary area, although accurate values of *C* cannot readily be determined. For most developed areas, the apparent values range from 0.6 to 1.0. However, values as low as 0.20 for *C* may be assumed in areas with low intensity design rainfall and high infiltration rates on flat terrain. A value of 0.6 may be assumed for areas left ungraded where meandering-flow and appreciable natural-ponding exists, slopes are 1 percent or less, and vegetal cover is relatively dense. A value of 1.0 may be assumed applicable to paved areas and to smooth areas of substantial slope with virtually no potential for surface storage and little or no vegetal cover.

(2) The design intensity is selected from the appropriate intensity-duration-frequency relationship for the critical time of concentration and for the design storm frequency. Time of concentration is usually defined as the time required, under design storm conditions, for runoff to travel from the most remote point of the drainage area to the point in question. In computing time of concentration, it should be kept in mind that, even for uniformly graded bare or turfed ground, overland flow in "sheet" form will rarely travel more than 300 or 400 feet before becoming channelized and thence move relatively faster; a method which may be used for determining travel-time for sheet flow is given in TM 5-820-1/AFM 88-5, Chap 1. Also, for design, the practical minimum time of concentration for roofs or paved areas and for relatively small unpaved areas upstream of the uppermost inlet of a drainage system is 10 minutes; smaller values are rarely justifiable; values up to 20 minutes may be used if resulting runoff excesses will not cause appreciable damage. A minimum time of 20 minutes is generally applicable for turfed areas. Further, the configuration of the most remote portion of the drainage area may be such that the time of concentration would be lengthened markedly and thus design intensity and peak runoff would be decreased substantially.

In such cases, the upper portion of the drainage areas should be ignored and the peak flow computation should be based only on the more efficient, downstream portion.

(3) For all durations, the infiltration rate is assumed to be the constant amount that is established following a rainfall of 1 hour duration. Where *F* varies considerably within a given drainage area, a weighted rate may be used; it must be remembered, however, that previous portions may require individual consideration, because a weighted overall value for *F* is proper only if rainfall intensities are equal to or greater than the highest infiltration rate within the drainage area.

In design of military construction drainage systems, factors such as initial rainfall losses and channel percolation rarely enter into runoff computations involving the Rational Method. Such losses are accounted for in the selection of the *C* coefficient.

c. Where basic hydrologic data on concurrent rainfall and runoff are adequate to determine unit hydrography for a drainage area, the uncertainties inherent in application of the Rational Method can largely be eliminated. Apparent loss rates determined from unit-hydrograph analyses of recorded floods provide a good basis for estimating loss rates for storms of design magnitude. Also, flow times and storage effects are accounted for in the shape of the unit-hydrograph. Where basic data are inadequate for direct determination of unit-hydrographs, use may be made of empirical methods for synthesis. Use of the unit-hydrograph method is particularly desirable where designs are being developed for ponds, detention reservoirs, and pump stations; where peak runoff from large tributary areas is involved in design; and where large-scale protective works are under consideration. Here, the volume and duration of storm runoff, as opposed to peak flow, may be the principal design criteria for determining the dimensions of hydraulic structures.

d. Procedures for routing storm runoff through reservoir-type storage and through stream channels can be found in publications listed in appendix E and in the available publications on these subjects.

CHAPTER 3

HYDRAULICS

3-1. General. Hydraulic design of the required elements of a system for drainage or for protective works may be initiated after functional design criteria and basic hydrologic data have been determined. The hydraulic design continually involves two prime considerations, namely, the flow quantities to which the system will be subjected, and the potential and kinetic energy and the momentum that are present. These considerations require that the hydraulic grade line and, in many cases, the energy grade line for design and pertinent relative quantities of flow be computed, and that conditions whereby energy is lost or dissipated must be carefully analyzed. The phenomena that occur in flow of water at, above, or below critical depth and in change from one of these flow classes to another must be recognized. Water velocities must be carefully computed not only in connection with energy and momentum considerations, but also in order to establish the extent to which the drainage lines and water-courses may be subjected to erosion or deposition of sediment, thus enabling determination of countermeasures needed. The computed velocities and possible resulting adjustments to the basic design layout often affect certain parts of the hydrology. Manning's equation is most commonly used to compute the mean velocities of essentially horizontal flow that occurs in most elements of a system:

$$V = \frac{1.486}{n} R^{2/3} S^{1/2}$$

The terms are defined in appendix D. Values of n for use in the formula are listed in chapters 2 and 9 of TM 5-820-3/AFM 88-5, Chapter 3.

3-2. Channels.

a. open channels on military installations range in form from graded swales and bladed ditches to large channels of rectangular or trapezoidal cross section. Swales are commonly used for surface drainage of graded areas around buildings and within housing developments. They are essentially triangular in cross section, with some bottom rounding and very flat side slopes, and normally no detailed computation of their flow-

carrying capacity is required. Ditches are commonly used for collection of surface water in outlying areas and along roadway shoulders. Larger open channels, which may be either wholly within the ground or partly formed by levees, are used principally for perimeter drains, for upstream flow diversion or for those parts of the drainage system within a built-up area where construction of a covered drain would be unduly costly or otherwise impractical. They are also used for rainfall drainage disposal. Whether a channel will be lined or not depends on erosion characteristics, possible grades, maintenance requirements, available space, overall comparative costs, and other factors. The need for providing a safety fence not less than 4 feet high along the larger channels (especially those carrying water at high velocity) will be considered, particularly in the vicinity of housing areas.

b. The discussion that follows will not attempt to cover all items in the design of an open channel; however, it will cite types of structures and design features that require special consideration.

c. Apart from limitations on gradient imposed by available space, existing utilities, and drainage confluences is the desirability of avoiding flow at or near critical depths. At such depths, small changes in cross section, roughness, or sediment transport will cause instability, with the flow depth varying widely above and below critical. To insure reasonable flow stability, the ratio of invert slope to critical slope should be not less than 1.29 for supercritical flow and not greater than 0.76 for subcritical flow. Unlined earth channel gradients should be chosen that will produce stable subcritical flow at nonerosive velocities. In regions where mosquito-borne diseases are prevalent, special attention must be given in the selection of gradients for open channels to minimize formation of breeding areas; pertinent information on this subject is given in TM 5-632/AFM 91-16.

d. Recommended maximum permissible velocities and Froude numbers for nonerosive flow are given in chapter 4 of TM 5-820-3/AFM 88-5, Chapter 3. Channel velocities and Froude numbers of

flow can be controlled by providing drop structures or other energy dissipators, and to a limited extent by widening the channel thus decreasing flow depths or by increasing roughness and depth. If nonerosive flows cannot be attained, the channel can be lined with turf, asphaltic or portland-cement concrete, and ungrouted or grouted rubble; for small ditches, half sections of pipe can be used, although care must be taken to prevent entrance and side erosion and undermining and ultimate displacement of individual sections. The choice of material depends on the velocity, depth and turbulence involved; on the quantities, availability, and cost of materials; and on evaluation of their maintenance. In choosing the material, its effect on flow characteristics may be an important factor. Further, if an impervious lining is to be used, the need for subdrainage and end protection must be considered. Where a series of drop structures is proposed, care must be taken to avoid placing them too far apart, and to insure that they will not be undermined by scour at the foot of the overpour. The design of energy dissipators and means for scour protection are discussed subsequently.

e. Side slopes for unlined earth channels normally will be no steeper than 1 on 3 in order to minimize maintenance and permit machine mowing of grass and weeds. Side-slope steepness for paved channels will depend on the type of material used, method of placement, available space, accessibility requirements of maintenance equipment, and economy. Where portland-cement concrete is used for lining, space and overall economic considerations may dictate use of a rectangular channel even though wall forms are required. Rectangular channels are particularly desirable for conveyance of supercritical channel flow. Most channels, however, will convey subcritical flow and be of trapezoidal cross section. For relatively large earth channels involving levees, side slopes will depend primarily on stability of materials used.

f. An allowance for freeboard above the computed water surface for a channel is provided so that during a design storm the channel will not overflow for such reasons as minor variations in the hydrology or future development, minor superelevation of flow at curves, formation of waves, unexpected hydraulic performance, embankment settlement, and the like. The allowance normally ranges from 0.5 to 3 feet, depending on the type of construction, size of channel, consequences of overflow, and degree of safety desired. Requirements are greater for leveed channels than those wholly within the ground because of the need to

guard against overtopping and breaching of embankments where failure would cause a sudden, highly damaging release of water. For areas upstream of culverts and bridges, the freeboard allowance should include possible rises in water-surface elevation due to occurrence of greater-than-design runoff, unforeseen entrance conditions, or blockage by debris. In high-velocity flows, the effect of entrained air on flow depth should be considered.

g. Whenever water flows in a curved alignment, superelevation of the water surface will occur, the amount depending on the velocity and degree of curvature. Further, if the water entering a curve is flowing at supercritical velocity, a wave will be formed on the surface at the initial point of change in direction, and this wave will be reflected back and forth across the channel in zigzag fashion throughout the curve and for a long distance along the downstream tangent. Where such rises in water surface are less than 0.5 foot, they may normally be ignored because the regular channel freeboard allowance is ample to contain them. Where the rises are substantial, channel wall heights can be held to a minimum and corresponding economy achieved by superelevating the channel bottom to fit the water-surface superelevation, and the formation of transverse waves (in supercritical flow) can be effectively eliminated by providing a spiral for each end of the curve. In superelevating the channel, the transition from horizontal to full tilt is accomplished in the spiral. Figure 3-1 is a chart indicating formulas pertinent for use in computing design wall heights under typical superelevation conditions. For practical reasons, the spirals generally used are a modified type consisting of a series of circular arcs of equal length and decreasing radius. Experience has shown that if the curve is to be superelevated, the length of the spiral transition L_t may be short, a safe minimum being given by the following equation.

$$L_t = 15 \frac{V^2 T}{R_c g}$$

If spirals are to be used in a non-superelevated channel, the minimum length of spiral L_s required is:

$$L_s = \frac{1.82 VT}{(gd)^{1/2}}$$

The terms in both equations are defined in appendix D. The rise in water surface at the outside bank of a curved channel with a trapezoidal section can be estimated by the use of the preceding formulas.

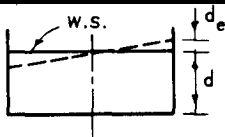
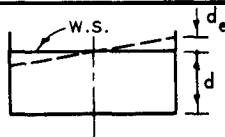
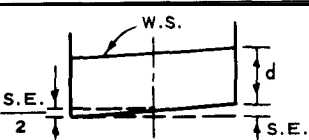
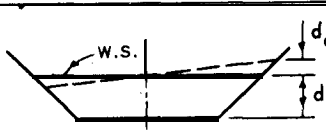
| DEPTH $> d_c$ SUBCRITICAL FLOW | SECTION | DEPTH $< d_c$ SUPERCRITICAL FLOW |
|---|--|--|
| $d_e = \frac{V^2 T}{2gR_c}$ $Ht = d + F.B. + d_e$ |  <p>HORIZONTAL INVERT NO SPIRAL</p> | $d'_e = \frac{V^2 T}{gR_c}$ $Ht = d + F.B. + d_e$ |
| $d_e = \frac{V^2 T}{2gR_c}$ $Ht = d + F.B. + d_e$ |  <p>HORIZONTAL INVERT SPIRAL TRANSITION</p> | $d'_e = \frac{V^2 T}{2gR_c}$ $Ht = d + F.B. + d_e$ |
| $S.E. = \frac{V^2 T}{gR_c}$ $Ht = d + F.B.$ |  <p>SUPERELEVATED INVERT SPIRAL TRANSITION</p> | $S.E. = \frac{V^2 T}{gR_c}$ $Ht = d + F.B.$ |
| $d_e = \frac{V^2 T}{2gR_c}$ $Ht = d + F.B. + d_e$ |  <p>HORIZONTAL INVERT WITH OR WITHOUT SPIRAL TRANSITION †</p> | $d'_e = \frac{V^2 T}{gR_c}$ $Ht = d + F.B. + d_e$ |

LEGEND

- F.B. FREEBOARD IN FEET
 - V VELOCITY IN FEET PER SECOND
 - d DEPTH IN FEET
 - d_e RISE ABOVE d DUE TO CENTRIFUGAL FORCE IN FEET
 - d'_e RISE ABOVE d DUE TO CENTRIFUGAL FORCE AND TRANSVERSE WAVES IN FEET
 - S.E. DIFFERENCE IN ELEVATION OF WATER SURFACE BETWEEN WALLS IN FEET
 - T TOP WIDTH AT WATER SURFACE IN FEET
 - R_c RADIUS OF CURVATURE CENTER LINE OF CHANNEL IN FEET
 - Ht WALL HEIGHT IN FEET
 - g ACCELERATION OF GRAVITY IN FEET PER SECOND²
- NOTE: WHEN SUPERELEVATION IS LESS THAN 0.5 FOOT NEGLECT THE SUPERELEVATION OF THE INVERT, BUT LET $Ht = \text{DEPTH} + \text{FREEBOARD} + \text{SUPERELEVATION}$.
- † IF MODEL STUDIES INDICATE THAT THE SPIRAL TRANSITION CURVE ELIMINATES THE TRANSVERSE WAVES FOR SUPERCRITICAL FLOW, USE d_e INSTEAD OF d'_e .

U. S. Army Corps of Engineers

Figure 3-1. Superelevation formulas.

h. For most open channel confluences, proper design can be accomplished satisfactorily by computations based on the principle of conservation of momentum. If the channel flows are supercritical, excessive waves and turbulence are likely to occur unless a close balance of forces is achieved. In such confluences, minimum disturbances will result if the tributary inflow is made to enter the main channel in a direction parallel to the main flow, and if the design depth and velocity of the tributary inflow are made equal to those in the main channel. Further, even though minimum disturbances appear likely under such design conditions, it must be remembered that natural floodflows are highly variable, both in magnitude and distribution. Since this variability leads to unbalanced forces and accompanying turbulence, a need may well exist for some additional wall height or freeboard allowance at and downstream from the confluence structure.

i. Side inflows to channels generally enter over the tops of the walls or in covered drains through the walls. If the main channel is earth, erosion protection frequently is required at (and perhaps opposite) the point of entry. If the sides of a channel through an erodible area are made of concrete or other durable materials and inflows are brought in over them, care must be taken to insure positive entry. There are two methods of conducting storm water into a concrete-lined channel. Entry of large flows over the top is provided by a spillway built as an integral part of the side slope while smaller flows are admitted to the channel by a conduit through the side slope. Gating of conduit is not required at this location because any pending is brief and not damaging. Where covered tributary drains enter, examination must be made to see whether the water in the main channel, if full, would cause damaging backflooding of the tributary area, which would be more damaging than temporary stoppage of the tributary flow. If so, means for precluding backflow must be employed; this can often be accomplished by a flap gate at the drain outfall, and if positive closure is required, a slide gate can be used. If flow in the main channel is supercritical, the design of side inlet structures may require special provisions to minimize turbulence effects.

3-3. Bridges.

a. A bridge is a structure, including supports, erected over a depression or an obstruction, such as water, a highway, or a railway, having a track or passageway for carrying traffic or other moving loads, and having an opening measured along

the center of the roadway of more than 20 feet between undercopings of abutments or spring lines of arches, or extreme ends of the openings for multiple boxes; it may include multiple pipes where the clear distance between openings is less than half of the smaller contiguous opening.

b. Sufficient capacity will be provided to pass the runoff from the design storm determined in accordance with principles given in chapter 2. Normally such capacity is provided entirely in the waterway beneath the bridge. Sometimes this is not practical, and it may be expedient to design one or both approach roadways as overflow sections for excess runoff. In such an event, it must be remembered that automobile traffic will be impeded, and will be stopped altogether if the overflow depth is much more than 6 inches. However, for the bridge proper, a waterway opening smaller than that required for 10-year storm runoff will be justifiable.

c. In general, the lowest point of the bridge superstructure shall clear the design water surface by not less than 2 feet for average flow and trash conditions. This may be reduced to as little as 6 inches if the flow is quiet, with low velocity and little or no trash. More than 2 feet will be required if flows are rough or large-size floating trash is anticipated.

d. The bridge waterway will normally be alined to result in the least obstruction to streamflow, except that for natural streams consideration will be given to realinement of the channel to avoid costly skews. To the maximum extent practicable, abutment wings will be alined to improve flow conditions. If a bridge is to span an improved trapezoidal channel of considerable width, the need for overall economy may require consideration of the relative structural and hydraulic merits of on-bank abutments with or without piers and warped channel walls with vertical abutments.

e. To preclude failure by underscour, abutment and pier footings will usually be placed either to a depth of not less than 5 feet below the anticipated depth of scour, or on firm rock if such is encountered at a higher elevation. Large multi-span structures crossing alluvial streams may require extensive pile foundations. To protect the channel against the increased velocities, turbulence, and eddies expected to occur locally, revetment of channel sides or bottom consisting of concrete, grouted rock, loose riprap, or sacked concrete will be placed as required. Criteria for selection of revetment are given in chapter 5.

f. Where flow velocities are high, bridges should

be of clear span, if at all practicable, in order to preclude serious problems attending debris lodgment and to minimize channel construction and maintenance costs.

g. It is important that storm runoff be controlled over as much of the contributing watershed as practicable. Diversion channels, terraces, check dams, and similar conventional soil conserving features will be installed, implemented, or improved to reduce velocities and prevent silting of channels and other downstream facilities. When practicable, unprotected soil surfaces within the drainage area will be planted with appropriate erosion-resisting plants. These parts of the drainage area which are located on private property or otherwise under control of others will be considered fully in the planning stages, and coordinated efforts will be taken to assure soil stabilization both upstream and downstream from the construction site.

h. Engineering criteria and design principles related to traffic, size, load capacity, materials, and structural requirements for highway and railroad bridges are given in TM 5-820-2/AFM 88-5, Chapter 2, and in AASHTO Standard Specifications for Highway Bridges, design manuals of the different railroad companies, and recommended practices of AREA Manual for Railway Engineering.

3-4. Curb-and-gutter sections.

a. Precipitation which occurs upon city streets and adjacent areas must be rapidly and economically removed before it becomes a hazard to traffic. Water falling on the pavement surface itself is removed from the surface and concentrated in the gutters by the provision of an adequate crown. The surface channel formed by the curb and gutter must be designed to adequately convey the runoff from the pavement and adjacent areas to a suitable collection point. The capacity can be computed by using the nomograph for flow in a triangular channel, figure 3-2. This figure can also be used for a battered curb face section, since the battering has negligible effect on the cross sectional area. Limited data from field tests with clear water show that a Manning's n of 0.013 is applicable for pavement. The n value should be raised when appreciable quantities of sediment are present. Figure 3-2 also applies to composite sections comprising two or more rates of cross slope.

b. Good roadway drainage practice requires the extensive use of curb-and-gutter sections in combination with spillway chutes or inlets and downspouts for adequate control of surface runoff, particularly in hilly and mountainous terrain where

it is necessary to protect roadway embankments against formation of rivulets and channels by concentrated flows. Materials used in such construction include portland-cement concrete, asphaltic concrete, stone rubble, sod checks, and prefabricated concrete or metal sections. Typical of the latter are the entrance tapers and embankment protectors made by manufacturers of corrugated metal products. Downspouts as small as 8 inches in diameter may be used, unless a considerable trash problem exists, in which case a large size will be required. When frequent mowing is required, consideration will be given to the use of buried pipe in lieu of open paved channels or exposed pipe. The hydrologic and hydraulic design and the provision of outfall erosion protection will be accomplished in accordance with principles outlined for similar component structures discussed in this manual.

c. Curbs are used to deter vehicles from leaving the pavement at hazardous points as well as to control drainage. The two general classes of curbs are known as barrier and mountable and each has numerous types and detail designs. Barrier curbs are relatively high and steep faced and designed to inhibit and to at least discourage vehicles from leaving the roadway. They are considered undesirable on high speed arterials. Mountable curbs are designed so that vehicles can cross them with varying degrees of ease.

d. Curbs, gutters, and storm drains will not be provided for drainage around tank-car or tank-truck unloading areas, tank-truck loading stands, and tanks in bulk-fuel-storage areas. Safety requires that fuel spillage must not be collected in storm or sanitary sewers. Safe disposal of fuel spillage of this nature may be facilitated by provision of ponded areas for drainage so that any fuel spilled can be removed from the water surface.

3-5. Culverts.

a. A drainage culvert is defined as any structure under the roadway with a clear opening of twenty feet or less measured along the center of the roadway. Culverts are generally of circular, oval, elliptical, arch, or box cross section and may be of either single or multiple construction, the choice depending on available headroom and economy. Culvert materials for permanent-type installations include plain concrete, reinforced concrete, corrugated metal, asbestos cement, and clay. Concrete culverts may be either precast or cast in place, and corrugated metal culverts may have either annular or helical corrugations and be con-

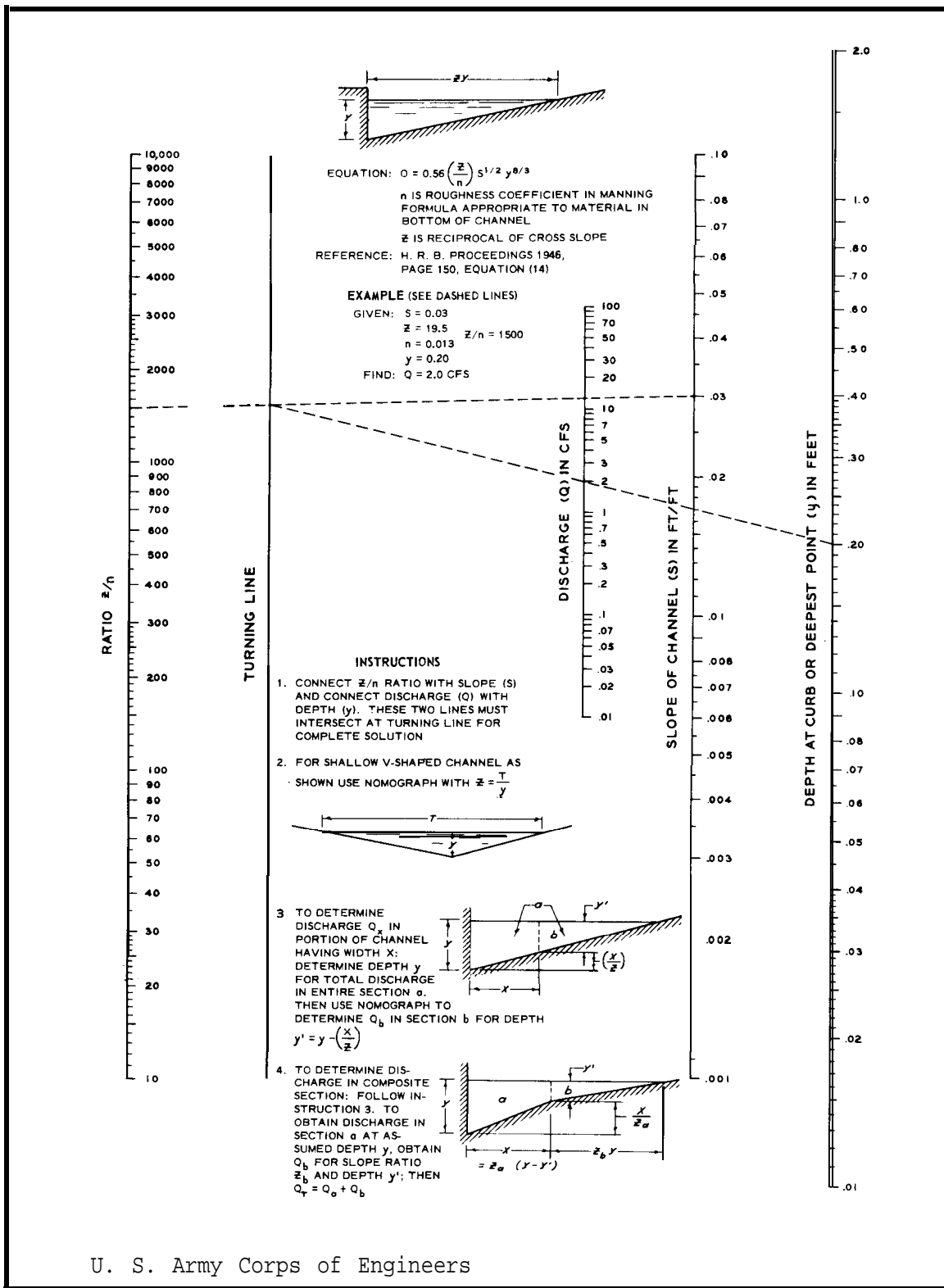

U. S. Army Corps of Engineers

Figure 3-2. Nomograph for flow in triangular channels.

structed of steel or aluminum. For the metal culverts, different kinds of coatings and linings are available for improvement of durability and hydraulic characteristics. The design of economical culverts involves consideration of many factors relating to requirements of hydrology, hydraulics, physical environment, imposed exterior loads, construction, and maintenance. With the design discharge and general layout determined, the design requires detailed consideration of such hydraulic factors as shape and slope of approach and exit channels, allowable head at entrance (and pending capacity, if appreciable), tailwater levels, hydraulic and energy grade lines, and erosion potential. A selection from possible alternative designs may depend on practical considerations such as minimum acceptable size, available materials, local experience concerning corrosion and erosion, and construction and maintenance aspects. If two or more alternative designs involving competitive materials of equivalent merit appear to be about equal in estimated cost, plans will be developed to permit contractor's options or alternate bids, so that the least construction cost will result.

- *b.* In most localities, culvert pipe is available in sizes to 36 inches diameter for plain concrete, 144 inches or larger for reinforced concrete, 120 inches for standard and helically corrugated metal (plain, polymer coated, bituminous coated, part paved, and fully paved interior), 36 inches for asbestos cement or clay, and 24 inches for corrugated polyethylene pipe. Concrete elliptical in sizes up to 116 x 180 inches, concrete arch in sizes up to 107 x 169 inches and reinforced concrete box sections in sizes from 3 x 2 feet to 12 x 12 feet are available. Structural plate, corrugated metal pipe can be fabricated with diameters from 60 to 312 inches or more. Corrugated metal pipe arches are generally available in sizes to 142 by 91 inches, and corrugated, structural plate pipe arches in spans to 40 feet. Reinforced concrete vertical oval (elliptical) pipe is available in sizes to 87 by 136 inches, and horizontal oval (elliptical) pipe is available in sizes to 136 by 87 inches. Designs for extra large sizes or for special shapes or structural requirements may be submitted by manufacturers for approval and fabrication. Short culverts under sidewalks (not entrances or driveways) may be as small as 8 inches in diameter if placed so as to be comparatively free from accumulation of debris or ice. Pipe diameters or pipe-arch rises should be not less than 18 inches. A diameter or pipe-arch of not less than 24 inches should be used in areas where wind-blown materials such as weeds and sand may tend to block the waterway. Within the above ranges of sizes, structural requirements may limit the maxi-

imum size that can be used for a specific installation.

c. The selection of culvert materials to withstand deterioration from corrosion or abrasion will be based on the following considerations:

- (1) Rigid culvert is preferable where industrial wastes, spilled petroleum products, or other substances harmful to bituminous paving and coating in corrugated metal pipe are apt to be present. Concrete pipe generally should not be used where soil is more acidic than pH 5.5 or where the fluid carried has a pH less than 5.5 or higher than 9.0. Polyethylene pipe is unaffected by acidic or alkaline soil conditions. Concrete pipe can be engineered to perform very satisfactorily in the more severe acidic or alkaline environments. Type II or Type V cements should be used where soils and/or water have a moderate or high sulfate concentration, respectively; criteria are given in Federal Specification SS-C-1960/GEN. High-density concrete pipe is recommended when the culvert will be subject to tidal drainage and salt-water spray. Where highly corrosive substances are to be carried, the resistive qualities of vitrified clay pipe or plastic lined concrete pipe should be considered.

- (2) Flexible culvert such as corrugated-steel pipe will be galvanized and generally will be bituminous coated for permanent installations. Bituminous coating or polymeric coating is recommended for corrugated steel pipe subjected to stagnant water; where dense decaying vegetation is present to form organic acids; where there is continuous wetness or continuous flow; and in well-drained, normally dry, alkali soils. The polymeric coated pipe is not damaged by spilled petroleum products or industrial wastes. Asbestos-fiber treatment with bituminous coated or a polymeric coated pipe is recommended for corrugated-steel pipe subjected to highly corrosive soils, cinder fills, mine drainage, tidal drainage, salt-water spray, certain industrial wastes, and other severely corrosive conditions; or where extra-long life is desirable. Cathodic protection is rarely required for corrugated-steel-pipe installations; in some instances, its use may be justified. Corrugated-aluminum-alloy pipe, fabricated in all of the shapes and sizes of the more familiar corrugated-steel pipe, evidences corrosion resistance in clear granular materials even when subjected to sea water. Corrugated-aluminum pipe will not be installed in soils that are highly acid (pH less than 5) or alkaline (pH greater than 9), or in metallic contact with other metals or metallic deposits, or where known corrosive conditions are present or where bacterial corrosion is known to exist. Similarly, this type pipe will

Change 1 3-7

not be installed in material classified as OH or OL according to the Unified Soil Classification System as presented in MIL-STD 619. Although bituminous coatings can be applied to aluminum-alloy pipe, such coatings do not afford adequate protection (bituminous adhesion is poor) under the aforementioned corrosive conditions. Suitable protective coatings for aluminum alloy have been developed, but are not economically feasible for culverts or storm drains. For flow carrying debris and abrasives at moderate to high velocity, paved-invert pipe may be appropriate. When protection from both corrosion and abrasion is required, smooth-interior corrugated-steel pipe may be desirable, since in addition to providing the desired protection, improved hydraulic efficiency of the pipe will usually allow a reduction in pipe size. When considering a coating for use, performance data from users in the area can be helpful. Performance history indicates various successes or failures of coatings and their probable cause and are available from local highway departments.

d. The capacity of a culvert is determined by its ability to admit, convey, and discharge water under specified conditions of potential and kinetic energy upstream and downstream. The hydraulic design of a culvert for a specified design discharge involves selection of a type and size, determination of the position of hydraulic control, and hydraulic computations to determine whether acceptable headwater depths and outfall conditions will result. In considering what degree of detailed refinement is appropriate in selecting culvert sizes, the relative accuracy of the estimated design discharge should be taken into account. Hydraulic computations will be carried out by standard methods based on pressure, energy, momentum, and loss considerations. Appropriate formulas, coefficients, and charts for culvert design are given in appendix B.

e. Rounding or beveling the entrance in any way will increase the capacity of a culvert for every design condition. Some degree of entrance improvement should always be considered for incorporation in design. A headwall will improve entrance flow over that of a projecting culvert. They are particularly desirable as a cutoff to prevent saturation sloughing and/or erosion of the embankment. Provisions for drainage should be made over the center of the headwall to prevent scouring along the sides of the walls. A mitered entrance conforming to the fill slope produces little if any improvement in efficiency over that of the straight, sharp-edged, projecting inlet, and may be structurally unsafe due to uplift forces. Both types of inlets tend to inhibit the culvert from flowing full when the inlet is submerged. The most effi-

cient entrances incorporate such geometric features as elliptical arcs, circular arcs, tapers, and parabolic drop-down curves. In general elaborate inlet designs for culverts are justifiable only in unusual circumstances.

f. Outlets and endwalls must be protected against undermining, bottom scour, damaging lateral erosion and degradation of the downstream channel. The presence of tailwater higher than the culvert crown will affect the culvert performance and may possibly require protection of the adjacent embankment against wave or eddy scour. Endwalls (outfall headwalls) and wingwalls should be used where practical, and wingwalls should flare one on eight from one diameter width to that required for the formation of a hydraulic jump and the establishment of a Froude number in the exit channel that will insure stability. Two general types of channel instability can develop downstream of a culvert. The conditions are known as either gully scour or a localized erosion referred to as a scour hole. Gully scour is to be expected when the Froude number of flow in the channel exceeds that required for stability. Erosion of this type maybe of considerable extent depending upon the location of the stable channel section relative to that of the outlet in both the vertical and downstream directions. A scour hole can be expected downstream of an outlet even if the downstream channel is stable. The severity of damage to be anticipated depends upon the conditions existing or created at the outlet. See chapter 5 for additional information on erosion protection.

g. In the design and construction of any drainage system it is necessary to consider the minimum and maximum earth cover allowable in the underground conduits to be placed under both flexible and rigid pavements. Minimum-maximum cover requirements for asbestos-cement pipe, corrugated-steel pipe, reinforced concrete culverts and storm drains, standard strength clay and non-reinforced concrete pipe are given in appendix C. The cover depths recommended are valid for average bedding and backfill conditions. Deviations from these conditions may result in significant minimum cover requirements.

h. Infiltration of fine-grained soils into drainage pipelines through joint openings is one of the major causes of ineffective drainage facilities. This is particularly a problem along pipes on relatively steep slopes such as those encountered with broken back culverts. Infiltration of backfill and subgrade material can be controlled by watertight flexible joint materials in rigid pipe and with watertight coupling bands in flexible pipe. The re-

sults of laboratory research concerning soil infiltration through pipe joints and the effectiveness of gasketing tapes for waterproofing joints and seams are available.

3-6. Underground hydraulic design.

a. The storm-drain system will have sufficient capacity to convey runoff from the design storm (usually a 10-year frequency for permanent installations) within the barrel of the conduit. Design runoff will be computed by the methods indicated in chapter 2. Concentration times will increase and average rainfall intensities will decrease as the design is carried to successive downstream points. In general, the incremental concentration times and the point-by-point totals should be estimated to the nearest minute. These totals should be rounded to the nearest 5 minutes in selecting design intensities from the intensity-duration curve. Advantage will be taken of any permanently available surface ponding areas, and their effectiveness determined, in order to hold design discharges and storm-drain sizes to a minimum. Experience indicates that it is feasible and practical in the actual design of storm drains to adopt minimum values of concentration times of 10 minutes for paved areas and 20 minutes for turfed areas. Minimum times of concentration should be selected by weighting for combined paved and turfed areas.

b. Storm-drain systems will be so designed that the hydraulic gradeline for the computed design discharge is as near optimum depth as practicable and velocities are not less than 2.5 feet per second (nominal minimum for cleansing) when the drains are one-third or more full. To minimize the possibility of clogging and to facilitate cleaning, the minimum pipe diameter or box section height will generally be not less than 12 inches; use of smaller size must be fully justified. Tentative size selections for capacity flow may be made from the nomography for computing required size of circular drains in appendix B, TM 5-820-1/AFM 88-5, Chapter 1. Problems attending high-velocity flow should be carefully analyzed, and appropriate provisions made to insure a fully functional project.

c. Site topography will dictate the location of possible outlets and the general limiting grades for the system. Storm drain depths will be held to the minimum consistent with limitations imposed by cover requirements, proximity of other structures, interference with other utilities, and velocity requirements because deep excavation is expensive. Usually in profile, proceeding downstream, the crowns of conduits whose sizes progressively

increase will be matched, the invert grade dropping across the junction structure; similarly, the crowns of incoming laterals will be matched to that of the main line. If the downstream conduit is smaller as on a steep slope, its invert will be matched to that of the upstream conduit. Some additional lowering of an outgoing pipe may be required to compensate for pressure loss within a junction structure.

d. Manholes or junction boxes usually will be provided at points of change in conduit grade or size, at junctions with laterals or branches and wherever entry for maintenance is required. Distance between points of entry will be not more than approximately 300 feet for conduits with a minimum dimension smaller than 30 inches. If the storm drain will be carrying water at a velocity of 20 feet per second or greater, with high energy and strong forces present, special attention must be given such items as alinement, junctions, anchorage requirements, joints, and selection of materials.

3-7. Inlets.

a. Storm-drain inlet structures to intercept surface flow are of three general types: drop, curb, and combination. Hydraulically, they may function as either weirs or orifices depending mostly on the inflowing water. The allowable depth for design storm conditions and consequently the type, size and spacing of inlets will depend on the topography of the surrounding area, its use, and consequences of excessive depths. Drop inlets, which are provided with a grated entrance opening, are in general more efficient than curb inlets and are useful in sumps, roadway sags, swales, and gutters. Such inlets are commonly depressed below the adjacent grade for improved interception or increased capacity. Curb inlets along sloping gutters require a depression for adequate interception. Combination inlets may be used where some additional capacity in a restricted space is desired. Simple grated inlets are most susceptible to blocking by trash. Also, in housing areas, the use of grated drop inlets should be kept to a reasonable minimum, preference being given to the curb type of opening. Where an abnormally high curb opening is needed, pedestrian safety may require one or more protective bars across the opening. Although curb openings are less susceptible to blocking by trash, they are also less efficient for interception on hydraulically steep slopes, because of the difficulty of turning the flow into them. Assurance of satisfactory performance by any system of inlets requires careful consideration of

the several factors involved. The final selection of inlet types will be based on overall hydraulic performance, safety requirements, and reasonableness of cost for construction and maintenance.

b. In placing inlets to give an optimum arrangement for flow interception, the following guides apply:

(1) At street intersections and crosswalks, inlets are usually placed on the upstream side. Gutters to transport flow across streets or roadways will not be used.

(2) At intermediate points on grades, the greatest efficiency and economy commonly result if either grated or curb inlets are designed to intercept only about three-fourths of the flow.

(3) In sag vertical curves, three inlets are often desirable, one at the low point and one on each side of the low point where the gutter grade is about 0.2 foot above the low point. Such a layout effectively reduces pond buildup and deposition of sediment in the low area.

(4) Large quantities of surface runoff flowing toward main thoroughfares normally should be intercepted before reaching them.

(5) At a bridge with curbed approaches, gutter flow should be intercepted before it reaches the bridge, particularly where freezing weather occurs.

(6) Where a road pavement on a continuous grade is warped in transitions between super-elevated and normal sections, surface water should normally be intercepted upstream of the point where the pavement cross slope begins to change, especially in areas where icing occurs.

(7) On roads where curbs are used, runoff from cut slopes and from off-site areas should, wherever possible, be intercepted by ditches at the tops of slopes or in swales along the shoulders and not be allowed to flow onto the roadway. This practice minimizes the amount of water to be intercepted by gutter inlets and helps to prevent mud and debris from being carried onto the pavement.

c. Inlets placed in sumps have a greater potential capacity than inlets on a slope because of the possible submergence in the sump. Capacities of grated, curb, and combination inlets in sumps will be computed as outlined below. To allow for blockage by trash, the size of inlet opening selected for construction will be increased above the computed size by 100 percent for grated inlets and 25 to 75 percent, depending on trash conditions, for curb inlets and combination inlets.

(1) *Grated type (in sump).*

(a) For depths of water up to 0.4 foot use

the weir formula:

$$Q = 3.0LH^{3/2}$$

If one side of a rectangular grate is against a curb, this side must be omitted in computing the perimeter.

(b) For depths of water above 1.4 feet use the orifice formula:

$$Q = 0.6A\sqrt{2gH}$$

(c) For depths between 0.4 and 1.4 feet, operation is indefinite due to vortices and other disturbances. Capacity will be somewhere between those given by the preceding formulas.

(d) Problems involving the above criteria may be solved graphically by use of figure 3-3.

(2) *Curb Type (in sump).* For a curb inlet in a sump, the above listed general concepts for weir and orifice flow apply, the latter being in effect for depths greater than about 1.4h (where h is the height of curb opening entrance). Figure 3-4 presents a graphic method for estimating capacity.

(3) *Combination Type (in sump).* For a combination inlet in a sump no specific formulas are given. Some increase in capacity over that provided singly by either a grated opening or a curb opening may be expected, and the curb opening will operate as a relief opening if the grate becomes clogged by debris. In estimating the capacity, the inlet will be treated as a simple grated inlet, but a safety factor of 25 to 75 percent will be applied.

(4) *Slotted drain type.* For a slotted drain inlet in a sump, the flow will enter the slot as either all orifice type or all weir type, depending on the depth of water at the edge of the slot. If the depth is less than .18 feet, the length of slot required to intercept total flow is equal to:

$$\frac{Q}{3.125 d^{3/2}}$$

If the depth is greater than .18 feet, the length of slot required to intercept total flow is equal to:

$$\frac{Q}{.5 w \sqrt{2gd}}$$

d = depth of flow-inches

w = width of slot---.146 feet

d. Each of a series of inlets placed on a slope is usually, for optimum efficiency, designed to intercept somewhat less than the design gutter flow, the remainder being passed to downstream inlets. The amount that must be intercepted is governed by whatever width and depth of bypassed flow can be tolerated from a traffic and safety viewpoint.

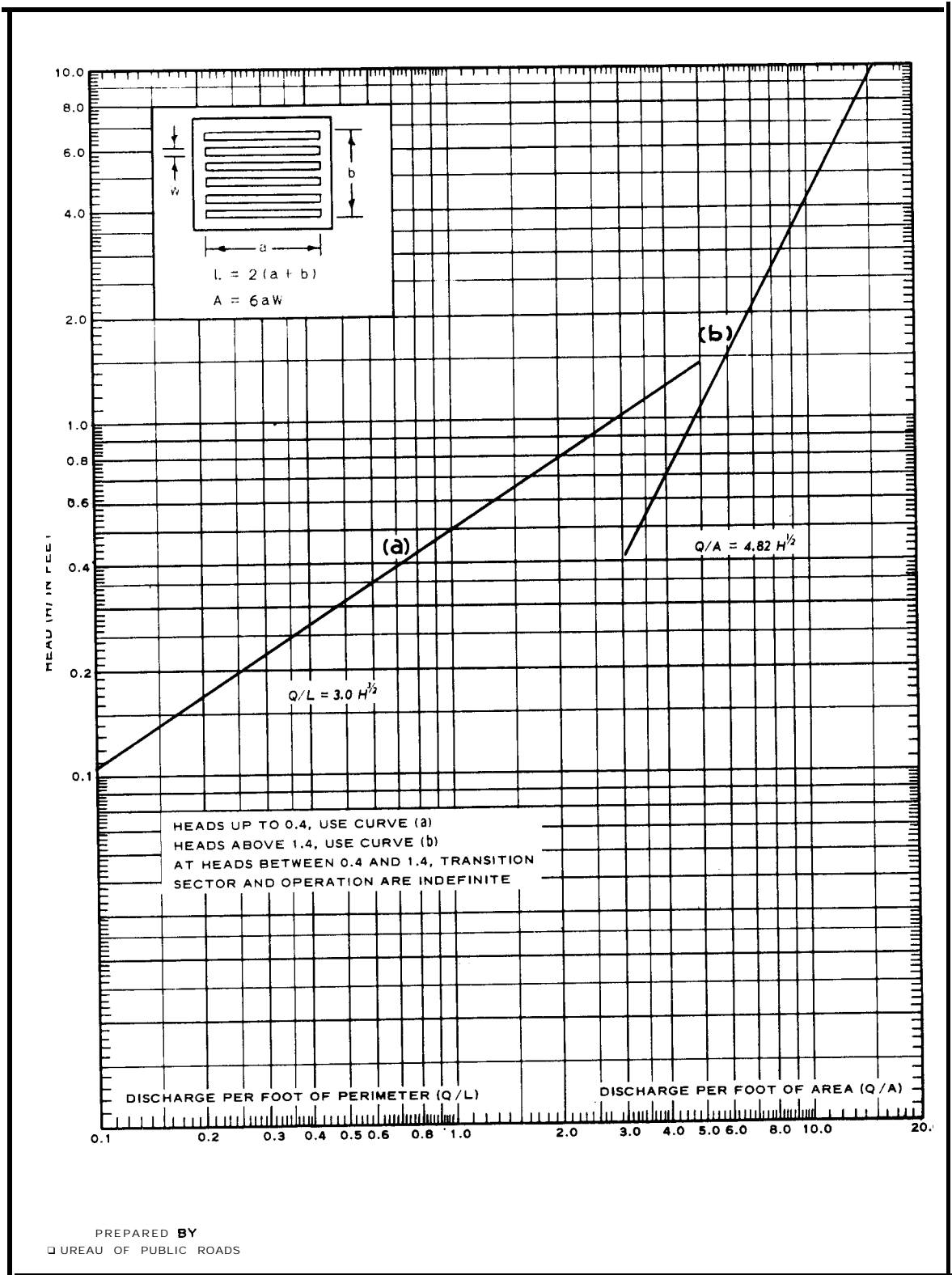

Figure 3-3. Capacity of grate inlet in sump water pond on grate.

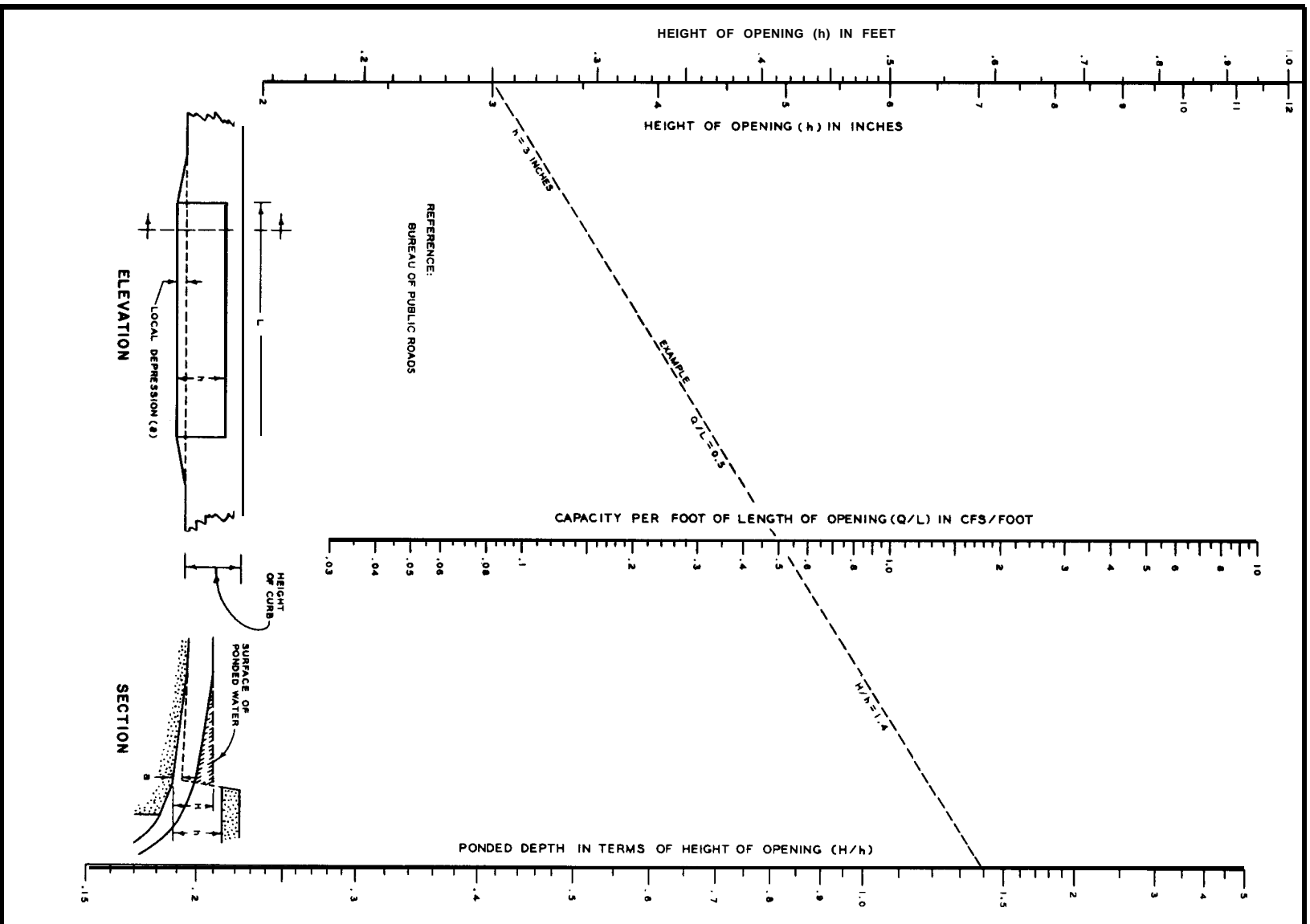

Figure 3-4. Capacity of curb opening inlet at low point in grade.

Such toleration levels will nearly always be influenced by costs of drainage construction. With the flat street crowns prevalent in modern construction, many gutter flows are relatively wide and in built-up areas some inconveniences are inevitable, especially in regions of high rainfall, unless an elaborate inlet system is provided. The achievement of a satisfactory system at reasonable cost requires careful consideration of use factors and careful design of the inlets themselves. However, it must also be remembered that a limitation on types and sizes for a given project is also desirable, for standardization will lead to lower construction costs. Design of grated, curb, and combination inlets on slopes will be based on principles outlined below.

(1) *Grated type (on slope)*. A grated inlet placed in a sloping gutter will provide optimum interception of flow if the bars are placed parallel to the direction of flow, if the openings total at least 50 percent of the width of the grate (i.e. normal to the direction of flow), and if the unobstructed opening is long enough (parallel to the direction of flow) that the water falling through will clear the downstream end of the opening. The minimum length of clear opening required depends on the depth and velocity of flow in the approach gutter and the thickness of the grate at the end of the slot. This minimum length may be estimated by the partly empirical formula:

$$L = \frac{V}{2} \sqrt{y+d}$$

A rectangular grated inlet in a gutter on a continuous grade can be expected to intercept all the water flowing in that part of the gutter cross section that is occupied by the grating plus an amount that will flow in along the exposed sides. However, unless the grate is over 3 feet long or greatly depressed (extreme warping of the pavement is seldom permissible), any water flowing outside the grate width can be considered to bypass the inlet. The quantity of flow in the prism intercepted by such a grate can be computed by following instruction 3 in figure 3-2. For a long grate the inflow along the side can be estimated by considering the edge of the grate as a curb opening whose effective length is the total grate length (ignoring crossbars) reduced by the length of the jet directly intercepted at the upstream end of the grate. To attain the optimum capacity of an inlet consisting of two grates separated by a short length of paved gutter, the grates should be so spaced that the carryover from the upstream grate will move sufficiently toward the curb to be intercepted by the downstream grate.

(2) *Curb type (on slope)*. In general, a curb inlet placed on a grade is a hydraulically inefficient structure for flow interception. A relatively long opening is required for complete interception because the heads are normally low and the direction of oncoming flows is not favorable. The cost of a long curb inlet must be weighed against that of a drop type with potentially costly grate. The capacity of a curb inlet intercepting all the flow can be calculated by an empirical equation. The equation is a function of length of clear opening of the inlet, depth of depression of flow line at inlet in feet, and the depth of flow in approach gutter in feet. Depression of the inlet flow line is an essential part of good design, for a curb inlet with no depression is very inefficient. The flow intercepted may be markedly increased without changing the opening length if the flow line can be depressed by one times the depth of flow in the approach gutter. The use of long curb openings with intermediate supports should generally be avoided because of the tendency for the supports to accumulate trash. If supports are essential, they should be set back several inches from the gutter line.

(3) *Combination type (on slope)*. The capacity of a combination inlet on a continuous grade is not much greater than that of the grated portion itself, and should be computed as a separate grated inlet except in the following situations. If the curb opening is placed upstream from the grate, the combination inlet can be considered to operate as two separate inlets and the capacities can be computed accordingly. Such an arrangement is sometimes desirable, for in addition to the increased capacity the curb opening will tend to intercept debris and thereby reduce clogging of the grate. If the curb opening is placed downstream from the grate, effective operation as two separate inlets requires that the curb opening be sufficiently downstream to allow flow bypassing the grate to move into the curb opening. The minimum separation will vary with both the cross slope and the longitudinal slope.

e. Structural aspects of inlet construction should generally be as indicated in figures 3-5, 3-6, and 3-7 which show respectively, standard circular grate inlets, types A and B; typical rectangular grate combination inlet, type C; and curb inlet, type D. It will be noted that the type D inlet provides for extension of the opening by the addition of a collecting trough whose backwall is cantilevered to the curb face. Availability of gratings and standards of municipalities in a given region may limit the choice of inlet types. Grated inlets subject to heavy wheel loads will require grates of

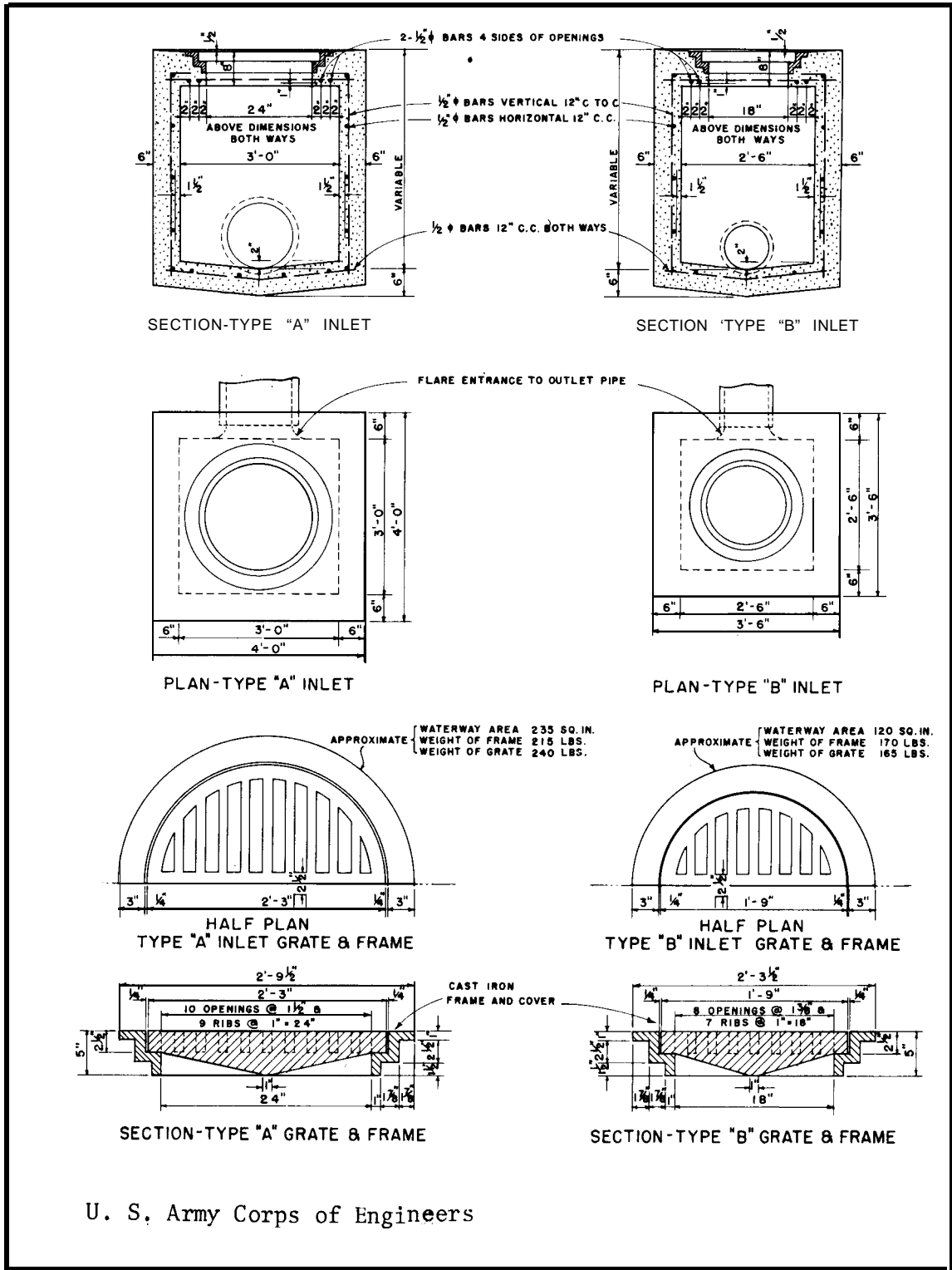

U. S. Army Corps of Engineers

Figure 3-5. Standard type "A" and type "B" inlets.

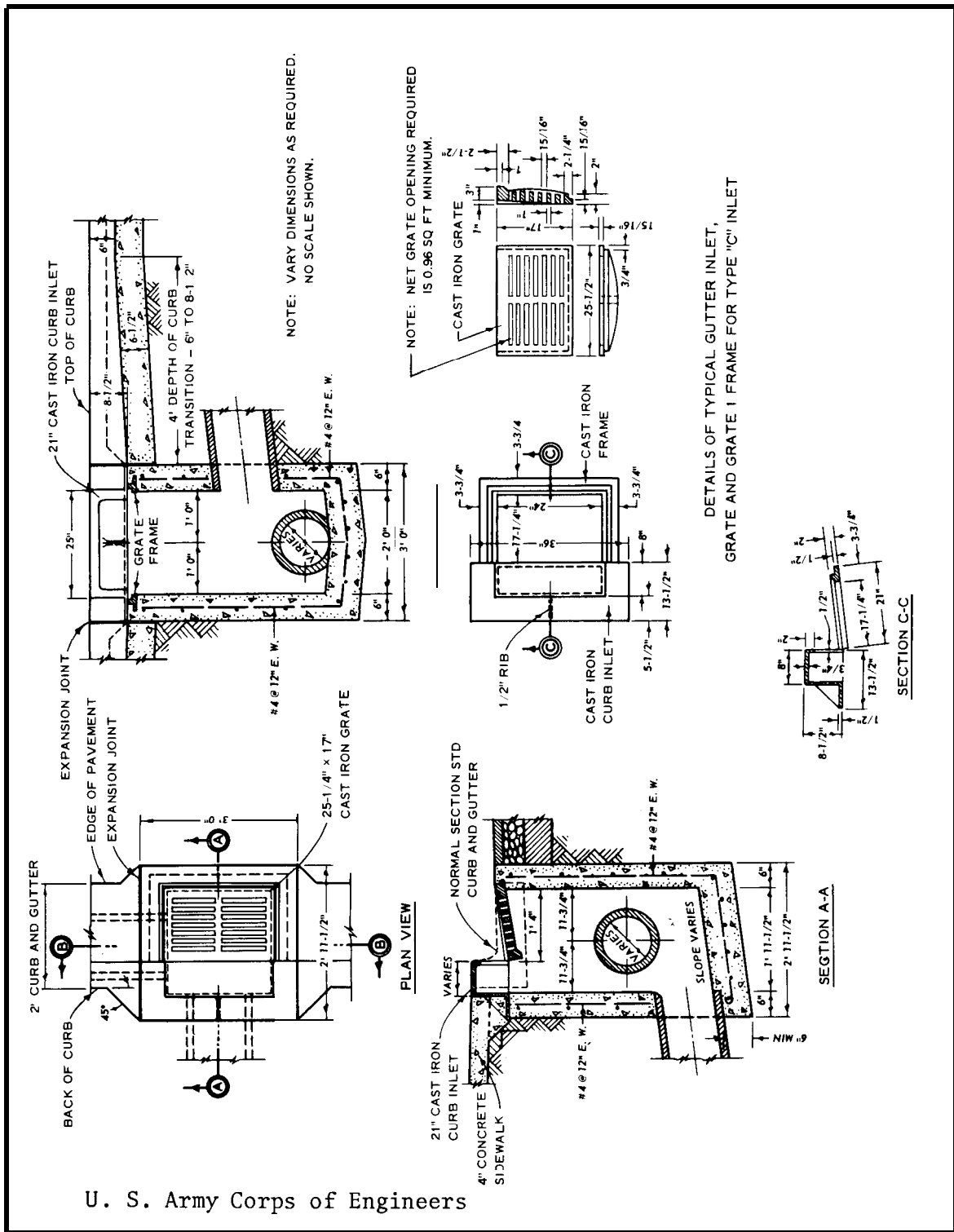

Figure 3-6. Type "C" inlet—square grating.

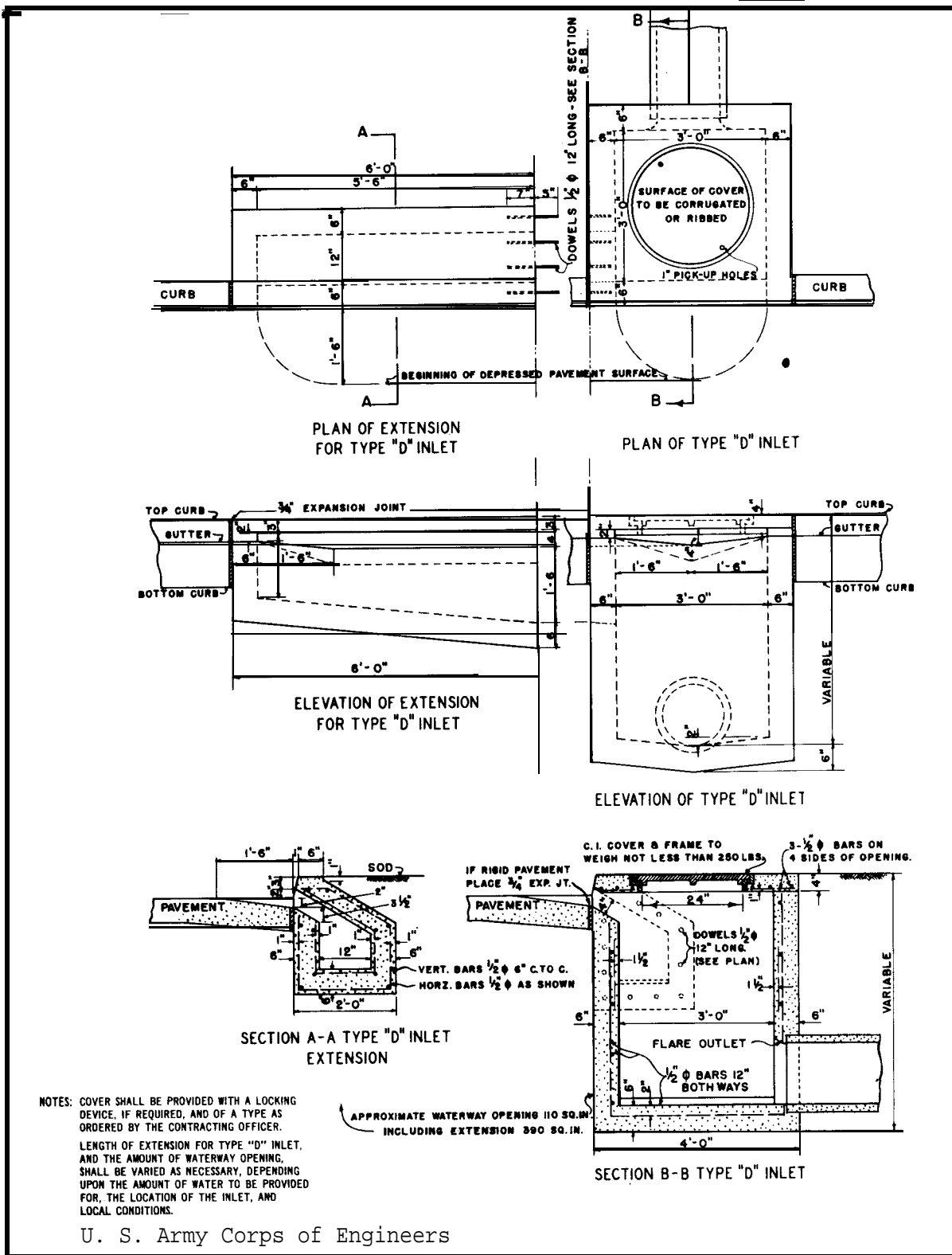

Figure 3-7. Standard type "D" inlet.

precast steel or of built-up, welded steel. Steel grates will be galvanized or bituminous coated. Unusual inlet conditions will require special design.

3-8. Vehicular safety and hydraulically efficient drainage practice.

a. Some drainage structures are potentially hazardous and, if located in the path of an errant vehicle, can substantially increase the probability of an accident. Inlets should be flush with the ground, or should present no obstacle to a vehicle that is out of control. End structures or culverts should be placed outside the designated recovery area wherever possible. If grates are necessary to

cover culvert inlets, care must be taken to design the grate so that the inlet will not clog during periods of high water. Where curb inlet systems are used, setbacks should be minimal, and grates should be designed for hydraulic efficiency and safe passage of vehicles. Hazardous channels or energy dissipating devices should be located outside the designated recovery area or adequate guard-rail protection should be provided.

b. It is necessary to emphasize that liberties should not be taken with the hydraulic design of drainage structures to make them safer unless it is clear that their function and efficiency will not be impaired by the contemplated changes. Even minor changes at culvert inlets can seriously disrupt hydraulic performance.

CHAPTER 4

HYDRAULIC STRUCTURES

4-1. Manholes and junction boxes. Drainage systems require a variety of appurtenances to assure proper operations. Most numerous appurtenances are manholes and junction boxes. Manholes and junction boxes are generally constructed of any suitable materials such as brick, concrete block, reinforced concrete, precast reinforced-concrete sections, or preformed corrugated metal sections. Manholes are located at intersections, changes in alignment or grade, and at intermediate joints in the system up to every 500 feet. Junction boxes for large pipes are located as necessary to assure proper operation of the drainage system. Inside dimensions of manholes will not be less than 2.5 feet. Inside dimensions of junction boxes will provide for not less than 3 inches of wall on either side of the outside diameter of the largest pipes involved. Manhole frames and cover will be provided as required; rounded manhole and box covers are preferred to square covers. Slab top covers will be provided for large manholes and junction boxes too shallow to permit corbeling of the upper part of the structure. A typical large box drain cover is shown in figure 3-5, TM 5-820-3/AFM 88-5, Chapter 3. Fixed ladders will be provided depending on the depth of the structures. Access to manhole and junction boxes without fixed ladders will be by portable ladders. Manhole and junction box design will insure minimum hydraulic losses through them. Typical manhole and junction box construction is shown in figures 4-1 through 4-3.

4-2. Detention pond storage. Hydrologic studies of the drainage area will reveal if detention ponds are required. Temporary storage or ponding may be required if the outflow from a drainage area is limited by the capacity of the drainage system serving a given area. A full discussion of temporary storage or ponding design will be found in appendix B, TM 5-820-1/AFM 88-5, Chapter 1. Ponding areas should be designed to avoid creation of a facility that would be unsightly, difficult to maintain, or a menace to health or safety.

4-3. Outlet energy dissipators.

a. Most drainage systems are designed to operate under normal free outfall conditions. Tailwater conditions are generally absent. However, it is possible for a discharge resulting from a drainage system to possess kinetic energy in excess of that which normally occurs in waterways. To reduce the kinetic energy, and thereby reduce downstream scour, outfalls may sometimes be required to reduce streambed scour. Scour may occur in the streambed if discharge velocities exceed the values listed in table 4-1. These values are to be used only as guides; studies of local materials must be made prior to a decision to install energy dissipation devices. Protection against scour may be provided by plain outlets, transitions and stilling basins. Plain outlets provide no protective works and depend on natural material to resist erosion. Transitions provide little or no dissipation of energy themselves, but by spreading the effluent jet to approximately the flow cross-section of the natural channel, the energy is greatly reduced prior to releasing the effluent into the outlet channel. Stilling basins dissipate the high kinetic energy of flow by a hydraulic jump or other means. Riprap may be required at any of the three types of outfalls.

(1) *Plain type.*

(a) If the discharge channel is in rock or a material highly resistant to erosion, no special erosion protection is required. However, since flow from the culvert will spread with a resultant drop

Table 4-1. Maximum Permissible Mean Velocities to Prevent Scour

| <i>Material</i> | <i>Maximum Permissible Mean Velocity</i> |
|--|--|
| Uniform graded sand and cohesionless silts | 1.5 fps |
| Well-graded sand | 2.5 fps |
| Silty sand | 3.0 fps |
| Clay | 4.0 fps |
| Gravel | 6.0 fps |

U.S. Army Corps of Engineers

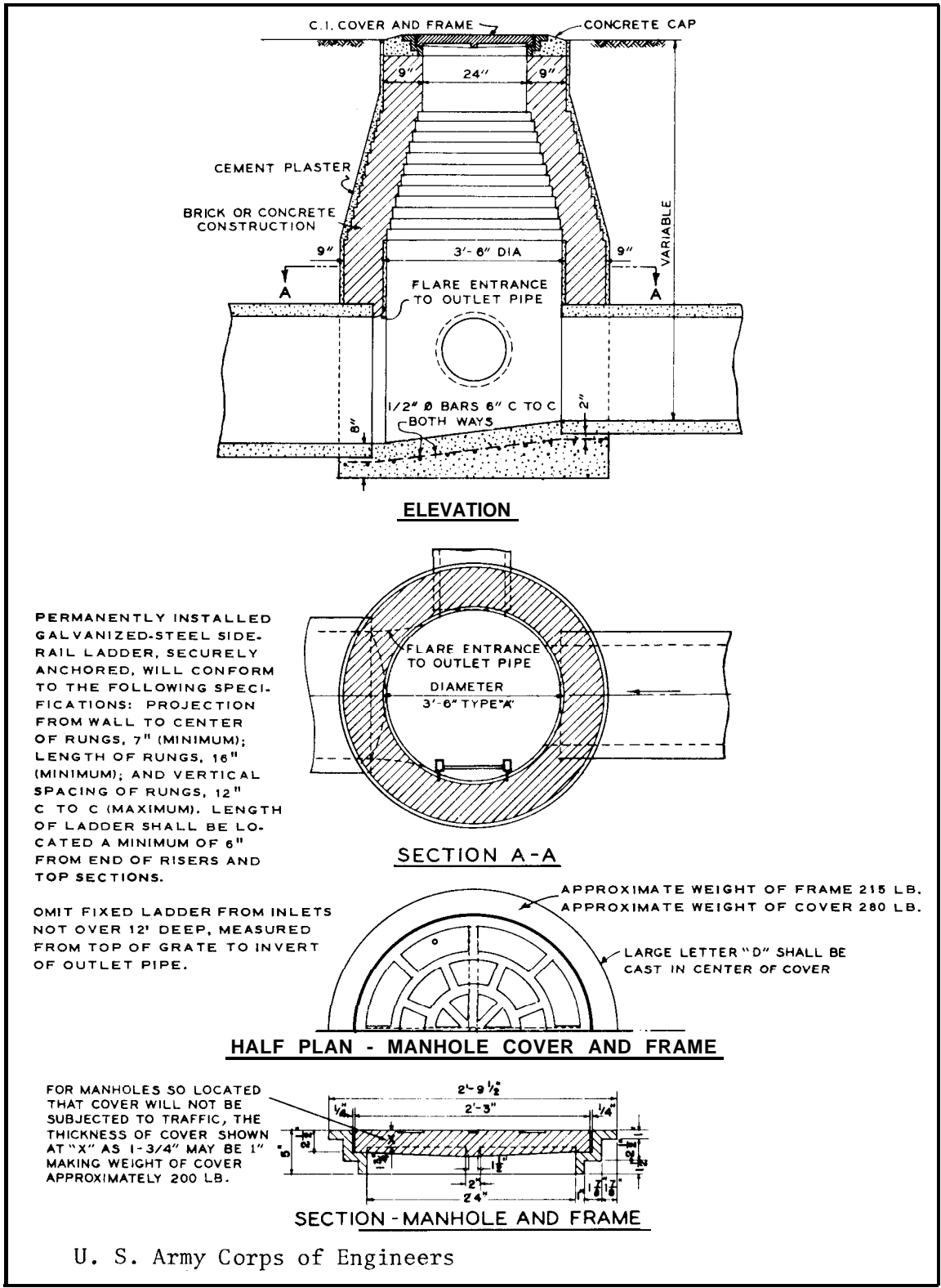

Figure 4-1. Standard storm drain manhole.

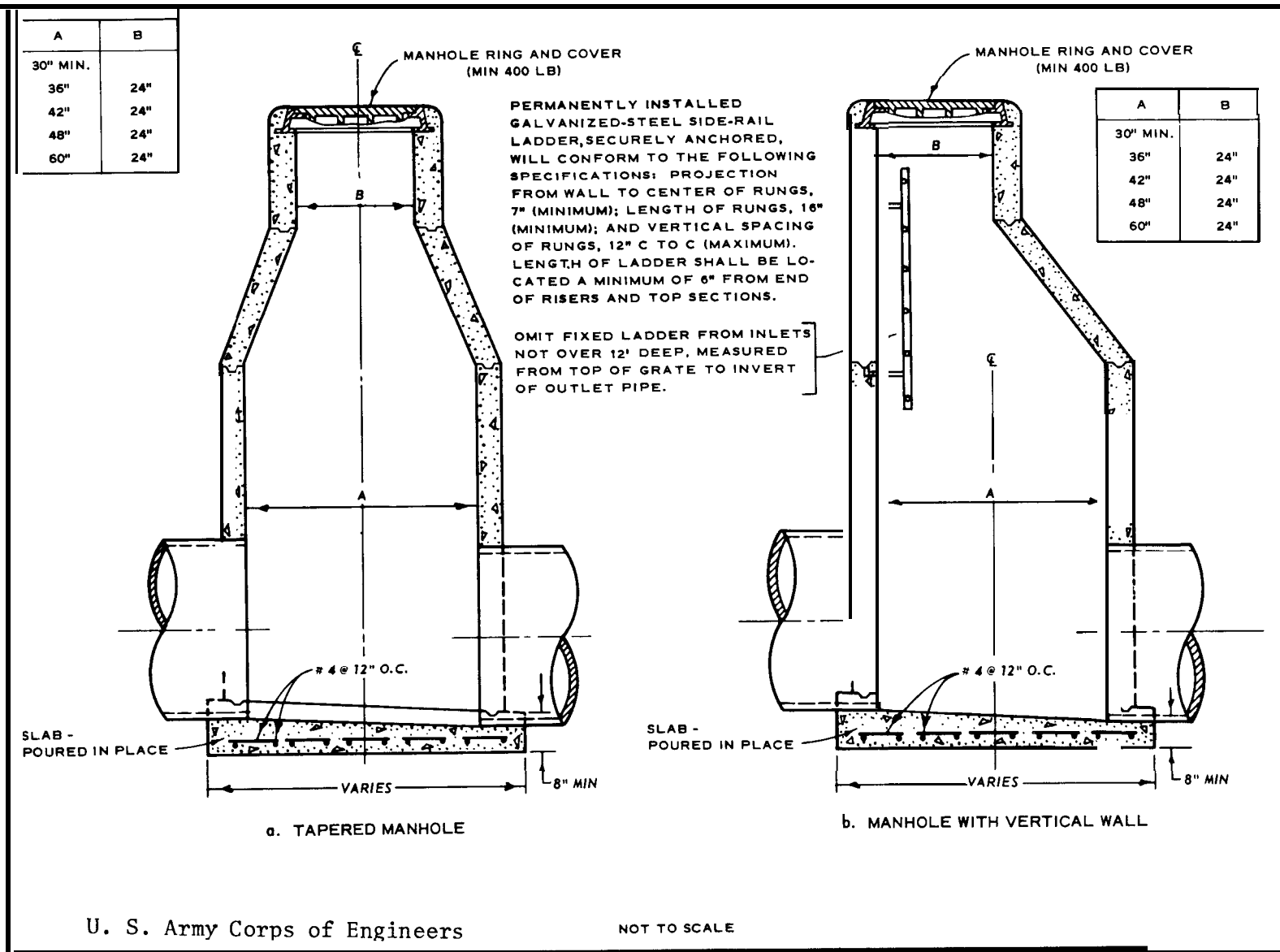

Figure 4-2. Standard precast manholes.

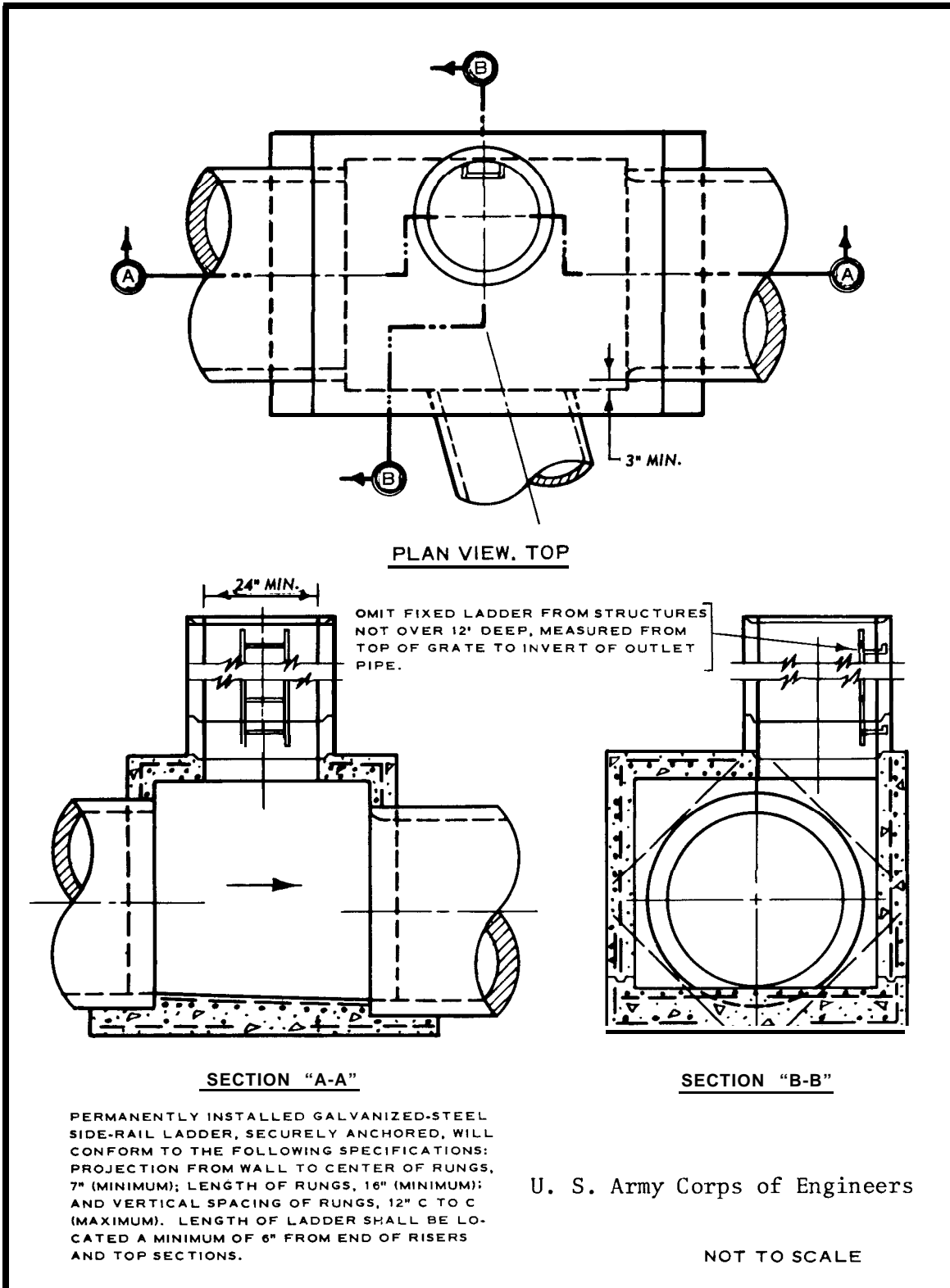

Figure 4-3. Junction details for large pipes.

in water surface and increase in velocity, this type of outlet should be used without riprap only if the material in the outlet channel can withstand velocities about 1.5 times the velocity in the culvert. At such an outlet, side erosion due to eddy action or turbulence is more likely to prove troublesome than is bottom scour.

(b) Cantilevered culvert outlets may be used to discharge a free-falling jet onto the bed of the outlet channel. A plunge pool will be developed, the depth and size of which will depend on the energy of the falling jet at the tailwater and the erodibility of the bed material.

(2) *Transition type.* Endwalls (outfall headwalls) serve the dual purpose of retaining the embankment and limiting the outlet transition boundary. Erosion of embankment toes usually can be traced to eddy attack at the ends of such walls. A flared transition is very effective, if proportioned so that eddies induced by the effluent jet do not continue beyond the end of the wall or overtop a sloped wall. As a guide, it is suggested that the product of velocity and flare angle should not exceed 150. That is, if effluent velocity is 5 feet per second each wingwall may flare 30 degrees; but if velocity is 15 feet per second, the flare should not exceed 10 degrees. Unless wingwalls can be anchored on a stable foundation, a paved apron between the wingwalls is required. Special care must be taken in design of the structure to preclude undermining. A newly excavated channel may be expected to degrade, and proper allowance for this action should be included in establishing the apron elevation and depth of cutoff wall. Warped endwalls provide excellent transitions in that they result in the release of flow in a trapezoidal section, which generally approximates the cross section of the outlet channel. If a warped transition is placed at the end of a curved section below a culvert, the transition is made at the end of the curved section to minimize the possibility of overtopping due to superelevation of the water surface. A paved apron is required with warped endwalls. Riprap usually is required at the end of a transition-type outlet.

(3) *Stilling basins.* A detailed discussion of stilling basins for circular storm drain outlets can be found in chapter 7, TM 5-820-3.

b. Improved channels, especially the paved ones, commonly carry water at velocities higher than those prevailing in the natural channels into which they discharge. Often riprap will suffice for dissipation of excess energy. A cutoff wall may be required at the end of a paved channel to preclude undermining. In extreme cases a flared transi-

tion, stilling basin, or impact device may be required.

4-4. Drop structures and check dams. Drop structures and check dams are designed to check channel erosion by controlling the effective gradient, and to provide for abrupt changes in channel gradient by means of a vertical drop. The structures also provide satisfactory means for discharging accumulated surface runoff over fills with heights not exceeding about 5 feet and over embankments higher than 5 feet provided the end sill of the drop structure extends beyond the toe of the embankment. The check dam is a modification of the drop structure used for erosion control in small channels where a less elaborate structure is permissible. Pertinent design features are covered in chapter 5, TM 5-820-3/AFM 88-5, Chapter 3.

4-5. Miscellaneous structures.

a. A chute is a steep open channel which provides a method of discharging accumulated surface runoff over fills and embankments. A typical design is included in chapter 6, TM 5-820-3/AFM 88-5, Chapter 3.

b. When a conduit or channel passes through or beneath a security fence and forms an opening greater than 96 square inches in area a security barrier must be installed. Barriers are usually of bars, grillwork, or chain-link screens. Parallel bars used to prevent access will be spaced not more than 6 inches apart, and will be of sufficient strength to preclude bending by hand after assembly.

(1) Where fences enclose maximum security areas such as exclusion and restricted areas, drainage channels, ditches, and equalizers will, wherever possible, be carried under the fence in one or more pipes having an internal diameter of not more than 10 inches. Where the volume of flow is such that the multipipe arrangement is not feasible, the conduit or culvert will be protected by a security grill composed of 3/4-inch-diameter rods or 1/2-inch bars spaced not more than 6 inches on center, set and welded in an internal frame. Where rods or bars exceed 18 inches in length, suitable spacer bars will be provided at not more than 18 inches on center, welded at all intersections. Security grills will be located inside the protected area. Where the grill is on the downstream end of the culvert, the grill will be hinged to facilitate cleaning and provided with a latch and padlock, and a debris catcher will be installed in the upstream end of the conduit or culvert. Elsewhere the grill will be permanently attached to the cul-

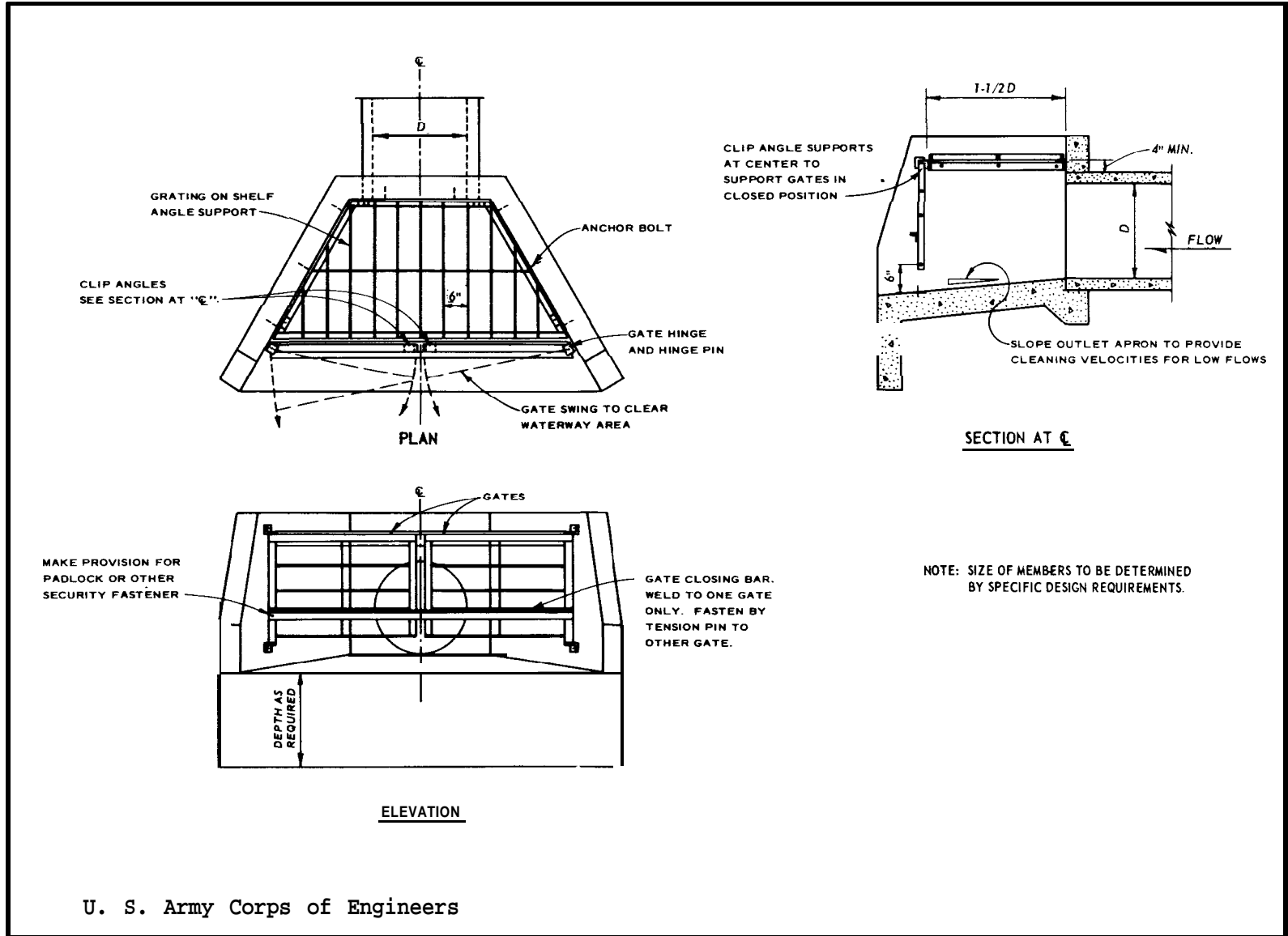

Figure 4-4. Outlet security barrier.

vert. Security regulations normally require the guard to inspect such grills at least once every shift. For culverts in rough terrain, steps will be provided to the grill to facilitate inspection and cleaning.

(2) For culverts and storm drains, barriers at the intakes would be preferable to barriers at the outlets because of the relative ease of debris removal. However, barriers at the outfalls are usually essential; in these cases consideration should be given to placing debris interceptors at the inlets. Bars constituting a barrier should be placed in a horizontal position, and the number of vertical members should be limited in order to minimize clogging; the total clear area should be at least twice the area of the conduit or larger under severe debris conditions. For large conduits an elaborate cage-like structure may be required. Provisions to facilitate cleaning during or immediately after heavy runoff should be made. Figure 4-4 shows a typical barrier for the outlet of a pipe drain. It will be noted that a 6-inch underclearance is provided to permit passage of normal bed-load material, and that the apron between the

conduit outlet and the barrier is placed on a slope to minimize deposition of sediment on the apron during ordinary flow. Erosion protection, where required, is placed immediately downstream from the barrier.

(3) If manholes must be located in the immediate vicinity of a security fence their covers must be so fastened as to prevent unauthorized opening.

(4) Open channels may present special problems due to the relatively large size of the waterway and the possible requirements for passage of large floating debris. For such channels a barrier should be provided that can be unfastened and opened or lifted during periods of heavy runoff or when clogged. The barrier is hinged at the top and an empty tank is welded to it at the bottom to serve as a float. Open channels or swales which drain relatively small areas and whose flows carry only minor quantities of debris may be secured merely by extending the fence down to a concrete sill set into the sides and across the bottom of the channel.

CHAPTER 5

EROSION CONTROL AND RIPRAP PROTECTION

5-1. General.

a. Hydraulic structures discharging into open channels will be provided with riprap protection to prevent erosion. Two general types of channel instability can develop downstream from a culvert and stormdrain outlet. The conditions are known as either gully scour or a localized erosion referred to as a scour hole. Distinction between the two conditions of scour and prediction of the type to be anticipated for a given field situation can be made by a comparison of the original or existing slope of the channel or drainage basin downstream of the outlet relative to that required for stability.

b. Gully scour is to be expected when the Froude number of flow in the channel exceeds that required for stability. It begins at a point downstream where the channel is stable and progresses upstream. If sufficient differential in elevation exists between the outlet and the section of stable channel, the outlet structure will be completely undermined. Erosion of this type may be of considerable extent depending upon the location of the stable channel section relative to that of the outlet in both the vertical and downstream directions.

c. A scour hole or localized erosion is to be expected downstream of an outlet even if the downstream channel is stable. The severity of damage to be anticipated depends upon the conditions existing or created at the outlet. In some instances, the extent of the scour hole may be insufficient to produce either instability of the embankment or structural damage to the outlet. However, in many situations flow conditions produce scour of the extent that embankment erosion as well as structural damage of the apron, end wall, and culvert are evident.

d. The results of research conducted at US Army Engineer Waterways Experiment Station to determine the extent of localized scour that may be anticipated downstream of culvert and storm-drain outlets has also been published. Empirical equations were developed for estimating the extent of the anticipated scour hole based on knowledge of the design discharge, the culvert diameter, and

the duration and Froude number of the design flow at the culvert outlet. These equations and those for the maximum depth, width, length and volume of scour and comparisons of predicted and observed values are discussed in chapter 10, TM 5-820-3/AFM 88-5, Chapter 3. Examples of recommended application to estimate the extent of scour in a cohesionless soil and several alternate schemes of protection required to prevent local scour downstream of a circular and rectangular outlet are illustrated in Practical Guidance for Design of Lined Channel Expansions at Culvert Outlets, Technical Report H-74-9.

5-2. Riprap protection,

a. Riprap protection should be provided adjacent to all hydraulic structures placed in erosive materials to prevent scour at the ends of the structure. The protection is required on the bed and banks for a sufficient distance to establish velocity gradients and turbulence levels at the end of the riprap approximating conditions in the natural channel. Riprap can also be used for lining the channel banks to prevent lateral erosion and undesirable meandering. Consideration should be given to providing an expansion in either or both the horizontal and vertical direction immediately downstream from hydraulic structures such as drop structures, energy dissipators, culvert outlets or other devices in which flow can expand and dissipate its excess energy in turbulence rather than in a direct attack on the channel bottom and sides.

b. There are three ways in which riprap has been known to fail: movement of the individual stones by a combination of velocity and turbulence; movement of the natural bed material through the riprap resulting in slumping of the blanket; and undercutting and raveling of the riprap by scour at the end of the blanket. Therefore, in design, consideration must be given to selection of an adequate size stone, use of an adequately graded riprap or provision of a filter blanket, and proper treatment of the end of the riprap blanket.

5-3. Selection of stone size. There are curves available for the selection of stone size required

for protection as a function of the Froude number. (See TM 5-820-3AFM 88-5, Chapter 3. Two curves are given, one to be used for riprap subject to direct attack or adjacent to hydraulic structures such as side inlets, confluences, and energy dissipators, where turbulence levels are high, and the other for riprap on the banks of a straight channel where flows are relatively quiet and parallel to the banks. With the depth of flow and average velocity in the channel known, the Froude number can be computed and a stone size determined from the appropriate curve. Curves for determining the riprap size required to prevent scour downstream from culvert outlets with scour holes of various depths are also available. The thickness of the riprap blanket should be equal to the longest dimension of the maximum size stone or 1.5 times the stone diameter (50 percent size), whichever is greater. When the use of very large rock is desirable but impractical, substitution of a grouted reach of smaller rock in areas of high velocities or turbulence maybe appropriate. Grouted riprap should be followed by an ungrouted reach.

5-4. Riprap gradation. A well-graded mixture of stone sizes is preferred to a relatively uniform size of riprap. In certain locations the available

material may dictate the gradation of riprap to be used. In such cases the gradation should resemble as closely as possible the recommended mixture. Consideration should be given to increasing the thickness of the riprap blanket when locality dictates the use of gradations with larger percents of small stone than recommended. If the gradation of the available riprap is such that movement of the natural material through the riprap blanket would be likely, a filter blanket of sand, crushed rock, gravel, or synthetic cloth must be placed under the riprap. The usual blanket thickness is 6 inches, but greater thickness is sometimes necessary.

5-5. Riprap design. An ideal riprap design would provide a gradual reduction in riprap size until the downstream end of the blanket blends with the natural bed material. This is seldom justified. However, unless this is done, turbulence caused by the riprap is likely to develop a scour hole at the end of the riprap blanket. It is suggested that the thickness of the riprap blanket be doubled at the downstream end to protect against undercutting and unraveling. An alternative is to provide a constant-thickness rubble blanket of suitable length dipping below the natural streambed to the estimated depth of bottom scour.

CHAPTER 6

SUBSURFACE DRAINAGE

6-1. General.

a. The water beneath the ground surface is defined as subsurface water. The free surface of this water, or the surface on which only atmospheric pressure acts, is called the groundwater table. Water is contained above an impervious stratum and hence the infiltration water is prevented from reaching a groundwater table at a lower elevation. The upper body of water is called perched groundwater and its free surface is called a perched water table.

b. This water infiltrates into the soil from surface sources, such as lakes, rivers and rainfall, and some portion eventually reaches the groundwater table. Groundwater tables rise and fall depending upon the relation between infiltration, absorption, evaporation and groundwater flow. Seasonal fluctuations are normal because of differences in the amount of precipitation and maybe relatively large in some localities. Prolonged drought or wet periods will cause large fluctuations in the groundwater level.

6-2. Subsurface drainage requirements. The determination of the subsurface soil properties and water condition is a prerequisite for the satisfactory design of a subsurface drainage system. Field explorations and borings made in connection with the project design should include the following investigations pertinent to subsurface drainage. A topographic map of the proposed area and the surrounding vicinity should be prepared indicating all streams, ditches, wells, and natural reservoirs. The analysis of aerial photographs of the areas selected for construction may furnish valuable information on general soil and groundwater conditions. An aerial photograph presents a graphic record of the extent, boundaries, and surface features of soil patterns occurring at the surface of the ground. The presence of vegetation, the slopes of a valley, the colorless monotony of sand plains, the farming patterns, the drainage pattern, gullies, eroded lands, and evidences of the works of man are revealed in detail by aerial photographs. The use of aerial photographs may supplement both the detail and knowledge gained in

topographic survey and ground explorations. The sampling and exploratory work can be made more rapid and effective after analysis of aerial photographs has developed the general soil features. The location and depth of permanent and perched groundwater tables maybe sufficiently shallow to influence the design. The season of the year and rainfall cycle will measurably affect the depth to the water table. In many locations information may be obtained from residents of the surrounding areas regarding the behavior of wells and springs and other evidences of subsurface water. The soil properties investigated for other purposes in connection with the design will supply information that can be used for the design of the drainage system. It may be necessary to supplement these explorations at locations of subsurface drainage structures and in areas where soil information is incomplete for design of the drainage system.

6-3. Laboratory tests. The design of subsurface drainage structures requires a knowledge of the following soil properties of the principal soils encountered: strength, compressibility, swell and dispersion characteristics, the in situ and compacted unit dry weights, the coefficient of permeability, the in situ water content, specific gravity, grain-size distribution, and the effective void ratio. These soil properties may be satisfactorily determined by experienced soil technicians through laboratory tests. The final selected soil properties for design purposes may be expressed as a range, one extreme representing a maximum value and the other a minimum value. The true value should be between these two extremes, but it may approach or equal one or the other, depending upon the variation within a soil stratum.

6-4. Flow of water through soils.

a. The flow of water through soils is expressed by Darcy's empirical law which states that the velocity of flow is directly proportional to the hydraulic gradient. This law is expressed in equation form as:

$$V = k i$$

or

$$Q = v A = k i A$$

Variables in the equations are defined in appendix D. According to Darcy's law the velocity of flow and the quantity of discharge through a porous media are directly proportional to the hydraulic gradient. The flow must be in the laminar regime for this condition to be true.

b. A thorough discussion of the Darcy equation including the limitations, typical values of permeability, factors affecting the permeability, effects of pore fluid and temperature, void ratio, average grain size, structure and stratification, formation discontinuities, entrapped air in water or void, degree of saturation, and fine soil fraction can be found in TM 5-820-2/AFM 88-5, Chapter 2.

6-5. Drainage of water from soil. The quantity of water removed by a drain will vary depending on the type of soil and location of the drain with respect to the groundwater table. All of the water contained in a given specimen cannot be removed by gravity flow since water retained as thin films adhering to the soil particles and held in the voids by capillarity will not drain. Consequently, to determine the volume of water that can be removed from a soil in a given time, the effective porosity as well as the permeability must be known. The

effective porosity is defined as the ratio of the volume of the voids that can be drained under gravity flow to the total volume of soil. Limited effective porosity test data for well-graded base-coarse materials, such as bank-run sands and gravels, indicate a value for effective porosity of not more than 0.15. Uniformly graded soils such as medium coarse sands, may have an effective porosity of not more than 0.25.

6-6. Backfill for subsurface drains.

a. Placing backfill in trenches around drain pipes should serve a dual purpose: it must prevent the movement of particles of the soil being drained, and it must be pervious enough to allow free water to enter the pipe without clogging it with fine particles of soil. The material selected for backfill is called filter material. An empirical criterion for the design of filter material was proposed by Terzaghi and substantiated by tests on protective filters used in the construction of earth dams. The criterion for a filter and pipe perforations to keep protected soil particles from entering the filter or pipe significantly is based on backfill particle sizes.

b. The filter stability criteria for preventing movement of particles from the protected soil into or through the filter and the exceptions to this criteria are discussed in chapter 5, TM 5-820-2/AFM 88-5, Chapter 2.

APPENDIX A

REFERENCES

Government Publications

Federal Specifications (Fed. Spec.)

- SS-C-1960/GEN Cement and Pozzolan, General Requirements for Pipe, Corrugated (Aluminum Alloy)
- WW-P-402C & Notice 1 and Am-1 Pipe, Corrugated (Iron or Steel, Zinc Coated)
- WW-P-405B & Am-1

Military Standards (Mil. Std.)

- MIL-STD-619B Unified Soil Classification System for Roads, Airfields, Embankments and Foundations
- MIL-STD-621A & Notices 1 & 2 Test Method for Pavement Subgrade, Subbase, and Base-Course Materials

Departments of the Army, Air Force, and the Navy

- TM 5-632/AFM 91-16 Military Entomology Operational Handbook
- TM 5-785/AFM 88-29/
NAVFAC P-89 Engineering Weather Data
- TM 5-820-1/AFM 88-5,
Chap. 1 Surface Drainage Facilities for Airfields and Heliports
- TM 5-820-2/AFM 88-5
Chap. 2 Drainage and Erosion Control: Subsurface Drainage Facilities for Airfields
- TM 5-820-3/AFM 88-5,
Chap. 3 Drainage and Erosion-Control Structures for Airfields and Heliports
- TM 5-852-7/AFM 88-19,
Chap. 7 Arctic and Subarctic Construction: Surface Drainage Design for Airfields and Heliports to Arctic and Subarctic Regions

Change 1 A-1

Engineers Waterways Experiment Station, P.O. Box 631, Vicksburg, Mississippi 39180

- Technical Report H-74-9, Practical Guidance for Design of Lined Channel Expansions at Culvert Outlets

Department of Commerce

National Oceanic and Atmospheric Administration, Environmental Data and Information Center, Federal Bldg., Asheville, N.C. 28801

Generalized Estimates of Probable Maximum Precipitation and Rainfall--Frequency Data for Puerto Rico and Virgin Islands, Technical Paper No. 42, 1961

Probable Maximum Precipitation and Rainfall--Frequency Data for Alaska, Technical Paper No. 47, 1963

Rainfall Frequency Atlas of the Hawaiian Islands, Technical Paper No. 43, 1962

Rainfall Frequency Atlas of the United States, Technical Paper' No. 40, 1961

Department of Transportation

Federal Aviation Administration, M 494.3, 400 7th Street, S. W., Washington, D.C. 20590

- Airport Drainage, AC 150/5320-5B, July 1970

ž Hydraulics of Bridge Waterways, J.N. Bradley, Hydraulic Design Series, No. 1, August 1960 (Revised March, 1978)

Non-Government Publications

American Association of State Highway and Transportation Officials (AASHTO), 444 N. Capital, N. W., Suite 225, Washington, D.C. 20001

ž T99-81 The Moisture-Density Relations of Soils Using a 5.5-lb (2.5 kg) Ramer and a 12-in. (305 MM) Drop

- HB-12 Highway Bridges (1977, 12th Ed.; Interim Specifications 1978, 1979, 1980, 1981, 1982, 1983)

American Railway Engineering Association (AREA), 2000 L Street, N. W., Washington, D.C. 20036

- Manual for Railway Engineering (Fixed Properties) (Current to Jul 31, 1982) (Supplement 1982-1983)
- Chapter 15 Steel Structures-1981

American Society of Civil Engineers (ASCE), United Engineering Center, 345 E. 47th Street, New York, N.Y. 10017

- Manuals and Reports on Engineering Practice
No. 37 Design and Construction of Sanitary and Storm Sewers, 1969 (Reprinted 1974)

A-2 Change 1

A-3 Change 1

APPENDIX B

HYDRAULIC DESIGN DATA FOR CULVERTS

B-1. General.

a. This appendix presents diagrams, charts, coefficients and related information useful in design of culverts. The information largely has been obtained from the U.S. Department of Transportation, Federal Highway Administration (formerly, Bureau of Public Roads), supplemented or modified as appropriate by information from various other sources and as required for consistency with design practice of the Corps of Engineers.

b. Laboratory tests and field observations show two major types of culvert flow: flow with inlet control and flow with outlet control. Under inlet control, the cross-sectional area of the culvert barrel, the inlet geometry and the amount of headwater or ponding at the entrance are of primary importance. Outlet control involves the additional consideration of the elevation of the tailwater in the outlet channel and the slope, roughness, and length of the culvert barrel. The type of flow or the location of the control is dependent on the quantity of flow, roughness of the culvert barrel, type of inlet, flow pattern in the approach channel, and other factors. In some instances the flow control changes with varying discharges, and occasionally the control fluctuates from inlet control to outlet control and vice versa for the same discharge. Thus, the design of culverts should consider both types of flow and should be based on the more adverse flow condition anticipated.

B-2. Inlet control. The discharge capacity of a culvert is controlled at the culvert entrance by the depth of headwater (HIV) and the entrance geometry, including the area, slope, and type of inlet edge. Types of inlet-controlled flow for unsubmerged and submerged entrances are shown at A and B in figure B-1. A mitered entrance (fig B-1C) produces little if any improvement in efficiency over that of the straight, sharp-edged, projecting inlet. Both types of inlets tend to inhibit the culvert from flowing full when the inlet is submerged. With inlet control the roughness and length of the culvert barrel and outlet conditions (including depths of tailwater) are not factors in determining culvert capacity. The effect of the bar-

rel slope on inlet-control flow in conventional culverts is negligible. Nomography for determining culvert capacity for inlet control were developed by the Division of Hydraulic Research, Bureau of Public Roads. (See *Hydraulics of Bridge Waterways*.) These nomography (figs B-2 through B-9) give headwater-discharge relations for most conventional culverts flowing with inlet control,

B-3. Outlet control.

a. Culverts flowing with outlet control can flow with the culvert barrel full or partially full for part of the barrel length or for all of it (fig B-10). If the entire barrel is filled (both cross section and length) with water, the culvert is said to be in full flow or flowing full (fig B-10A and B). The other two common types of outlet-control flow are shown in figure B-10C and D. The procedure given in this appendix for outlet-control flow does not give an exact solution for a free-water-surface condition throughout the barrel length shown in figure B-10D. An approximate solution is given for this case when the headwater, HW, is equal to or greater than 0.75D, where D is the height of the culvert barrel. The head, H, required to pass a given quantity of water through a culvert flowing full with control at the outlet is made up of three major parts. These three parts are usually expressed in feet of water and include a velocity head, an entrance loss, and a friction loss. The velocity head (the kinetic energy of the water in the culvert barrel) equals $\frac{v^2}{2g}$. The entrance loss varies with the type or design of the culvert inlet and is expressed as a coefficient K_e times the velocity head or $K_e \frac{V^2}{2g}$. Values of K_e for various types of culvert entrances are given in table B-1. The friction loss, H_f , is the energy required to overcome the roughness of the culvert barrel and is usually expressed in terms of Manning's n and the following expression:

$$H_f = \left(\frac{29n^2L}{R^{1.333}} \right) \left(\frac{V^2}{2g} \right)$$

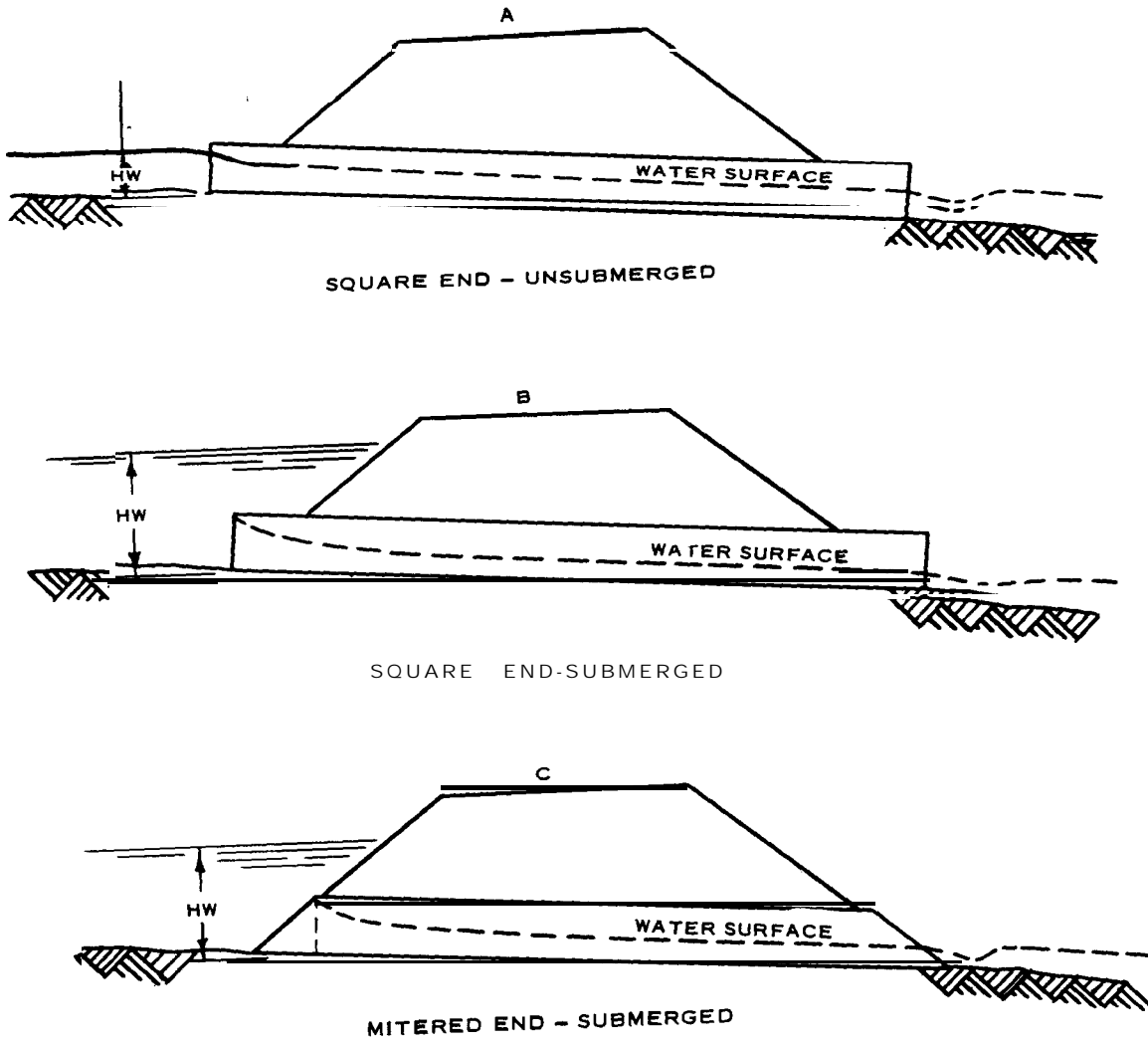

U. S. Army Corps of Engineers

Figure B-1. Inlet control.

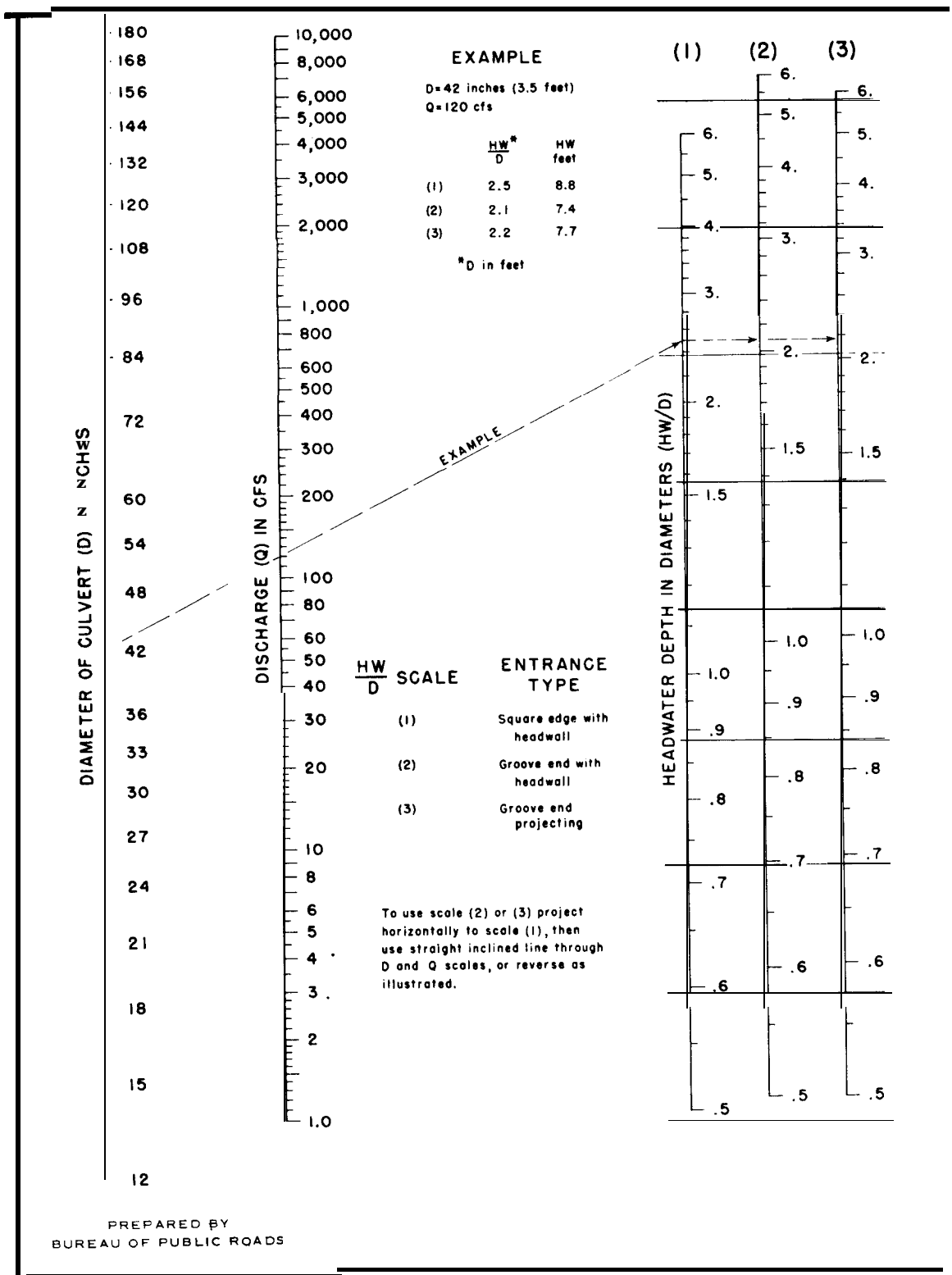

Figure B-2. Headwater depth for concrete pipe culverts with inlet control.

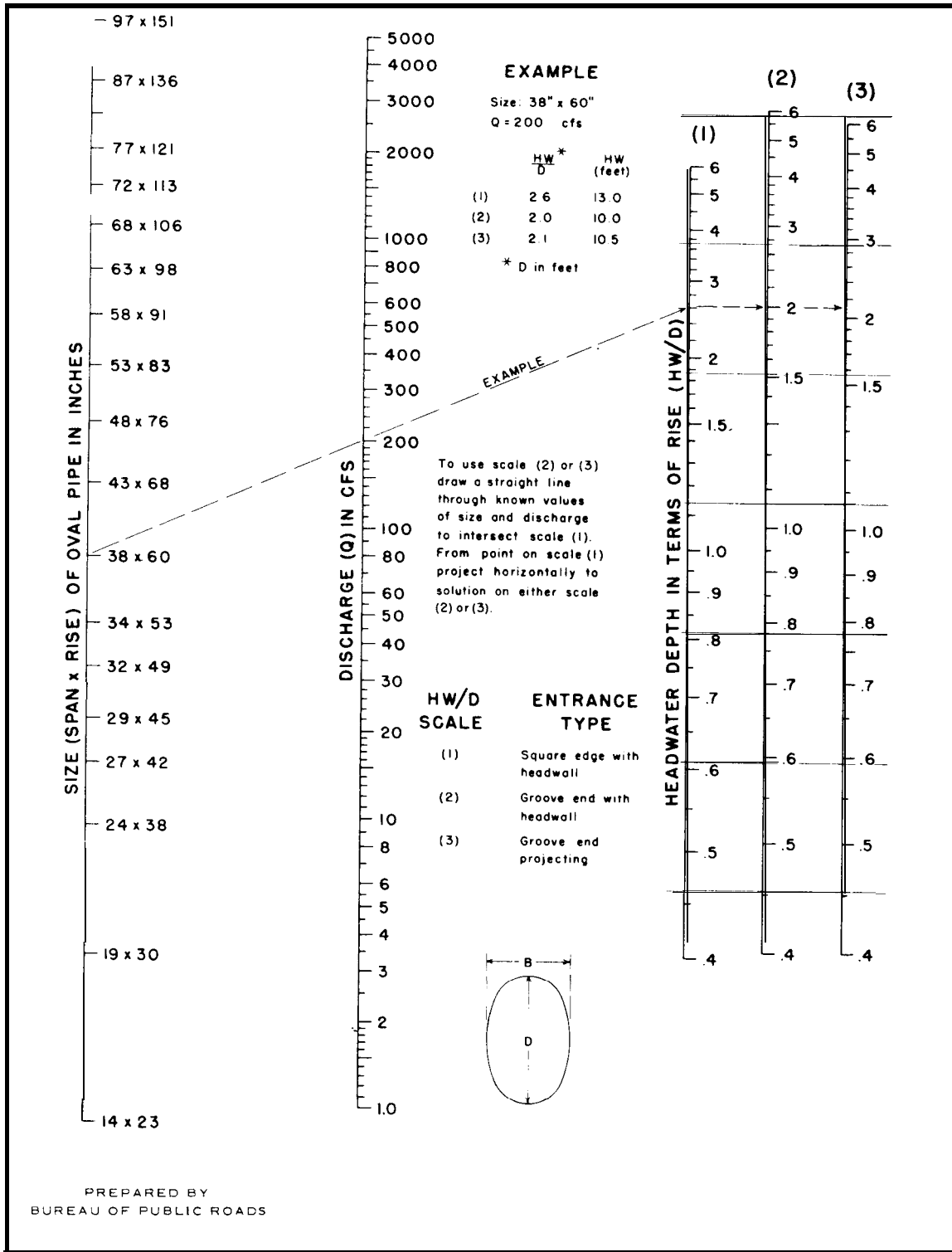

Figure B-3. Headwater depth for oval concrete pipe culverts long axis vertical with inlet control.

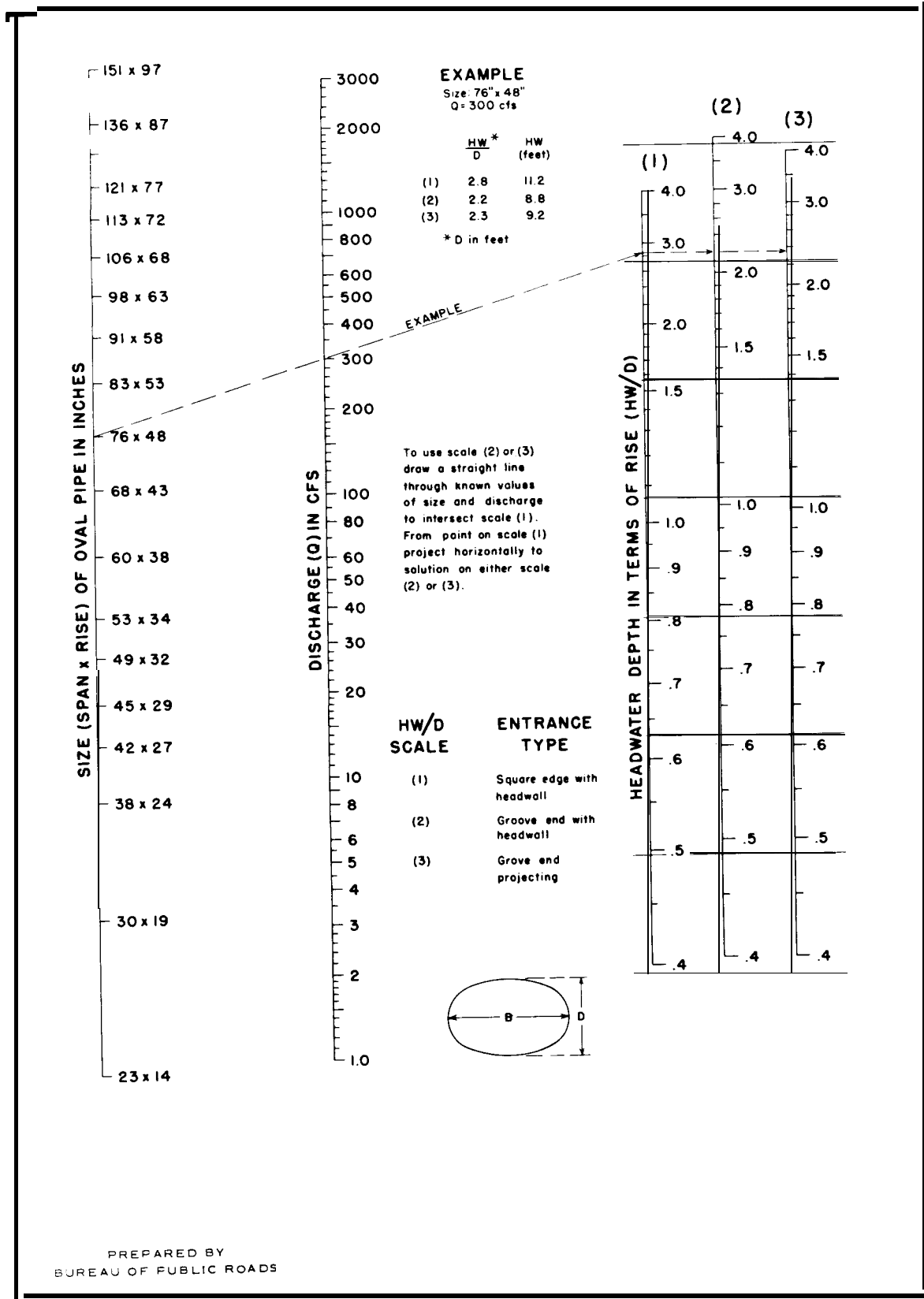

Figure B-4. Headwater depth for oval concrete pipe culverts long axis horizontal with inlet control.

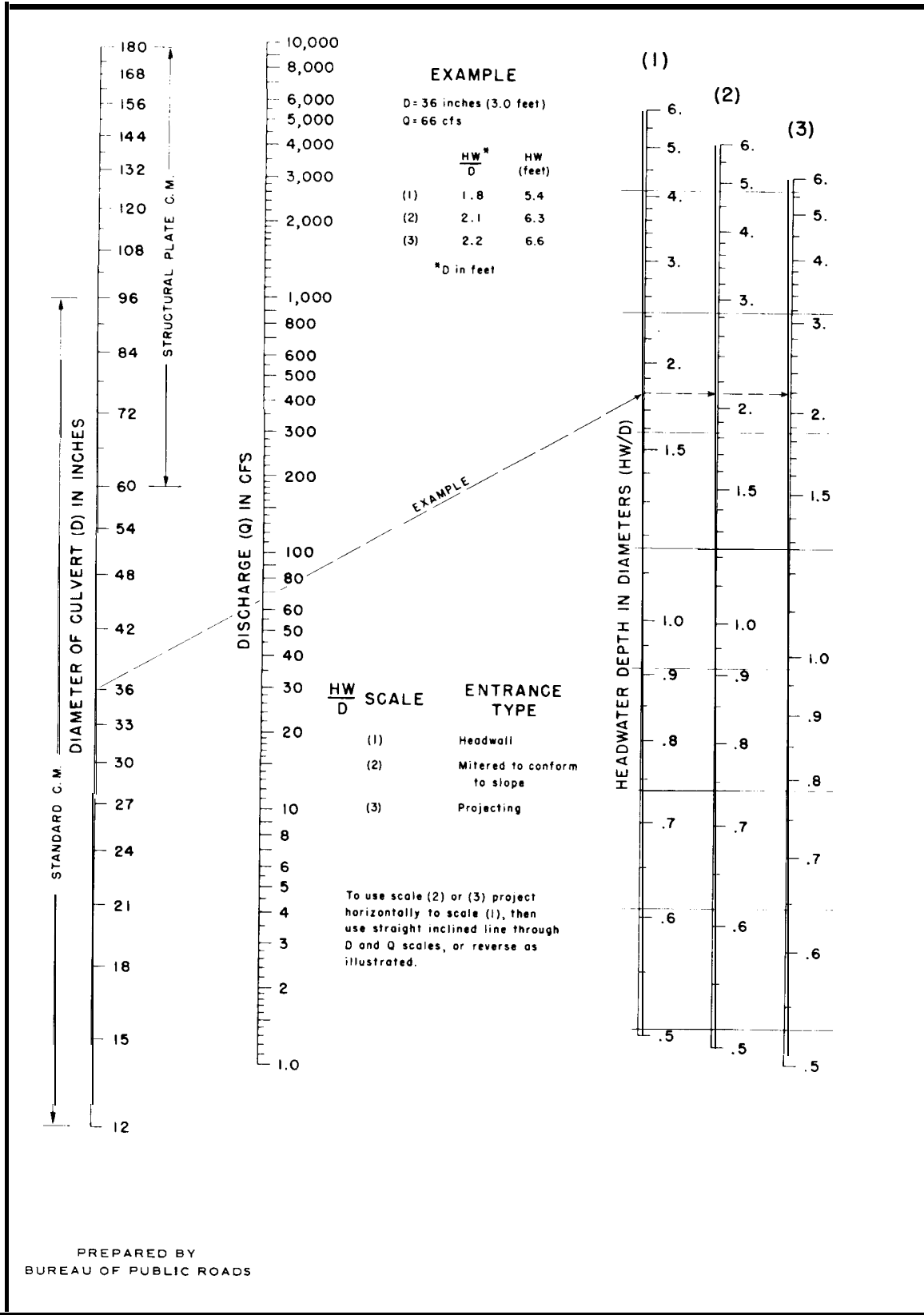

Figure B-5. Headwater depth for corrugated metal pipe culverts with inlet control.

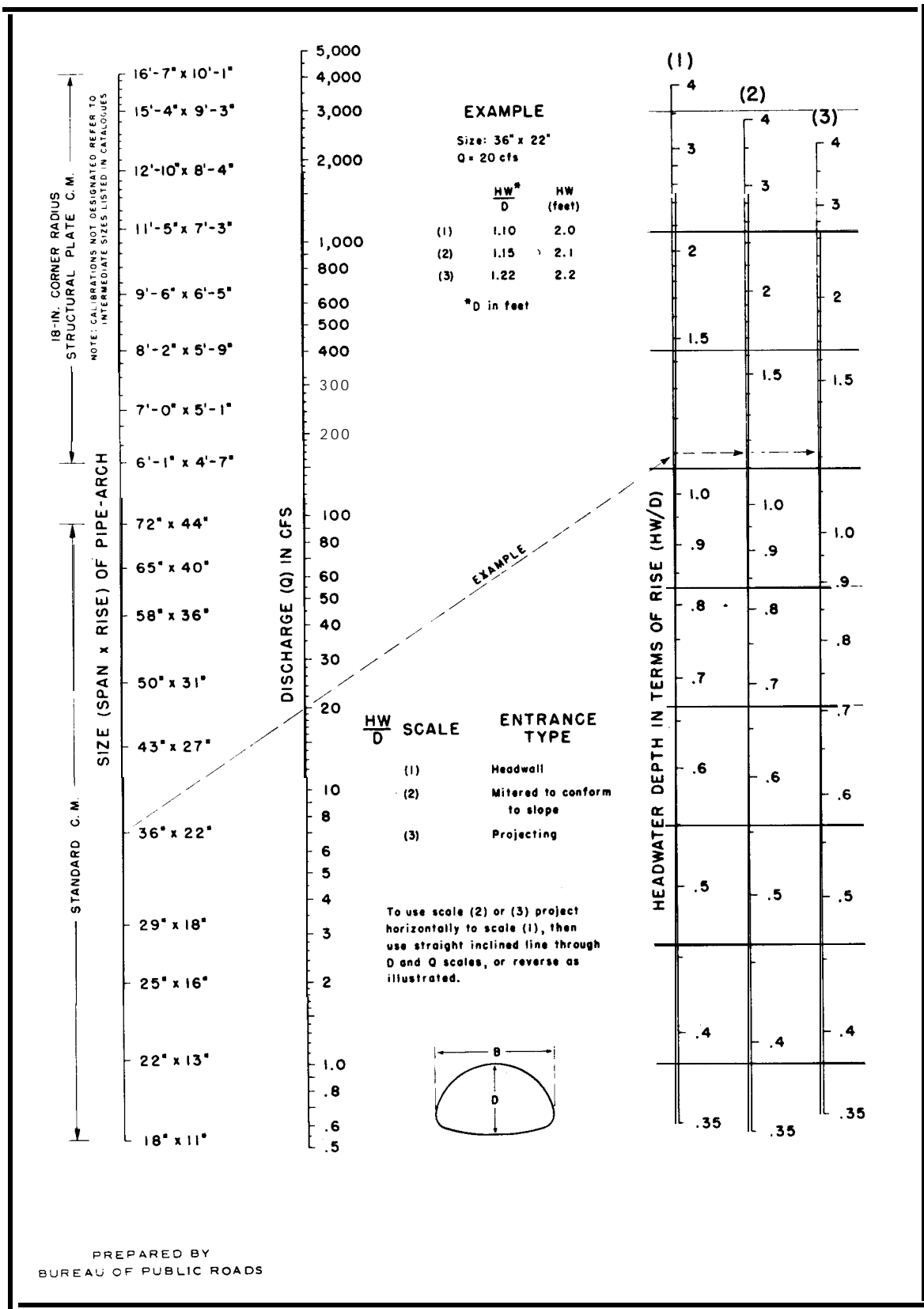

Figure B-6. Headwater depth for structural plate and standard corrugated metal pipe-arch culverts with inlet control.

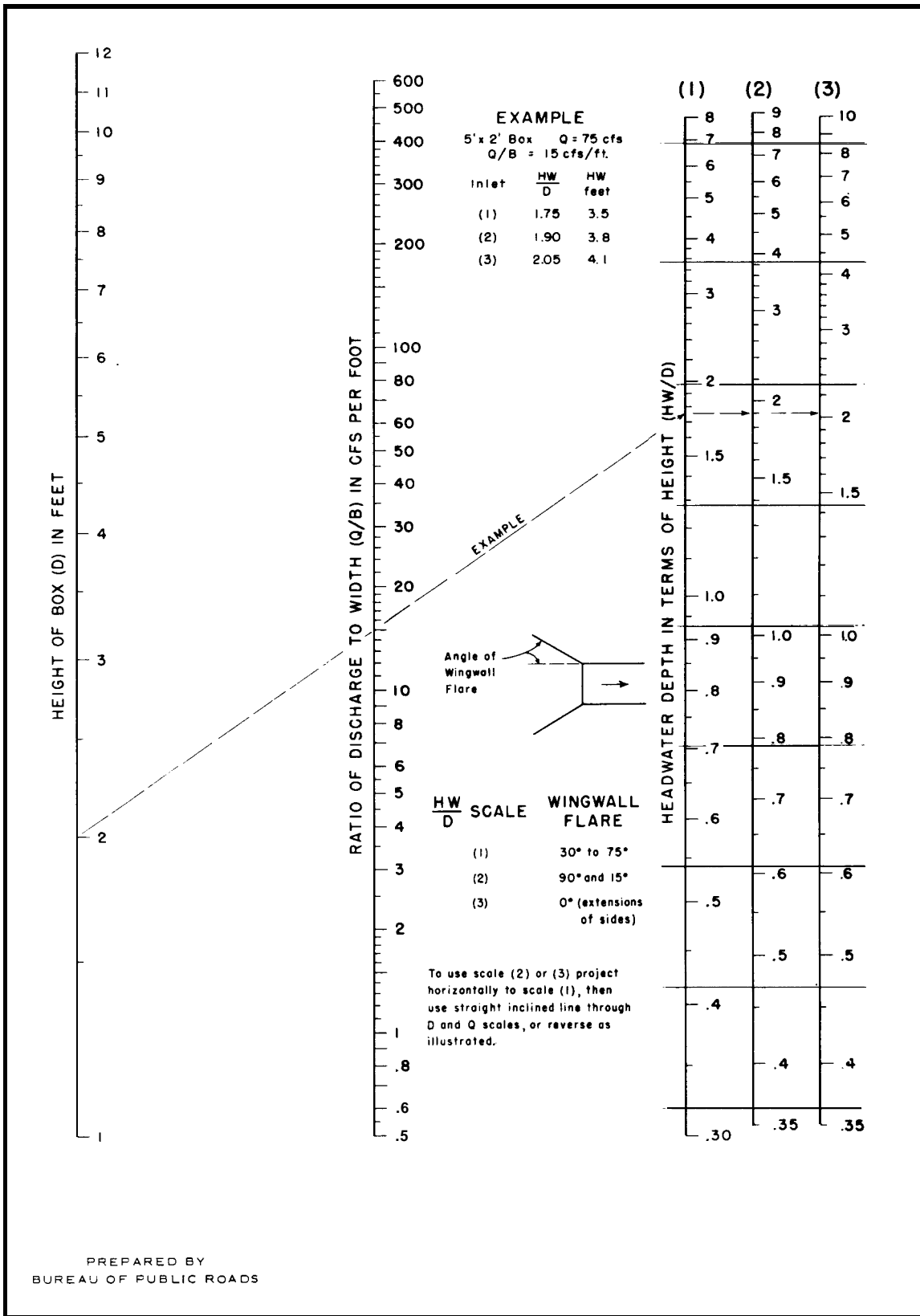

Figure B-7. Headwater depth for box culverts with inlet control.

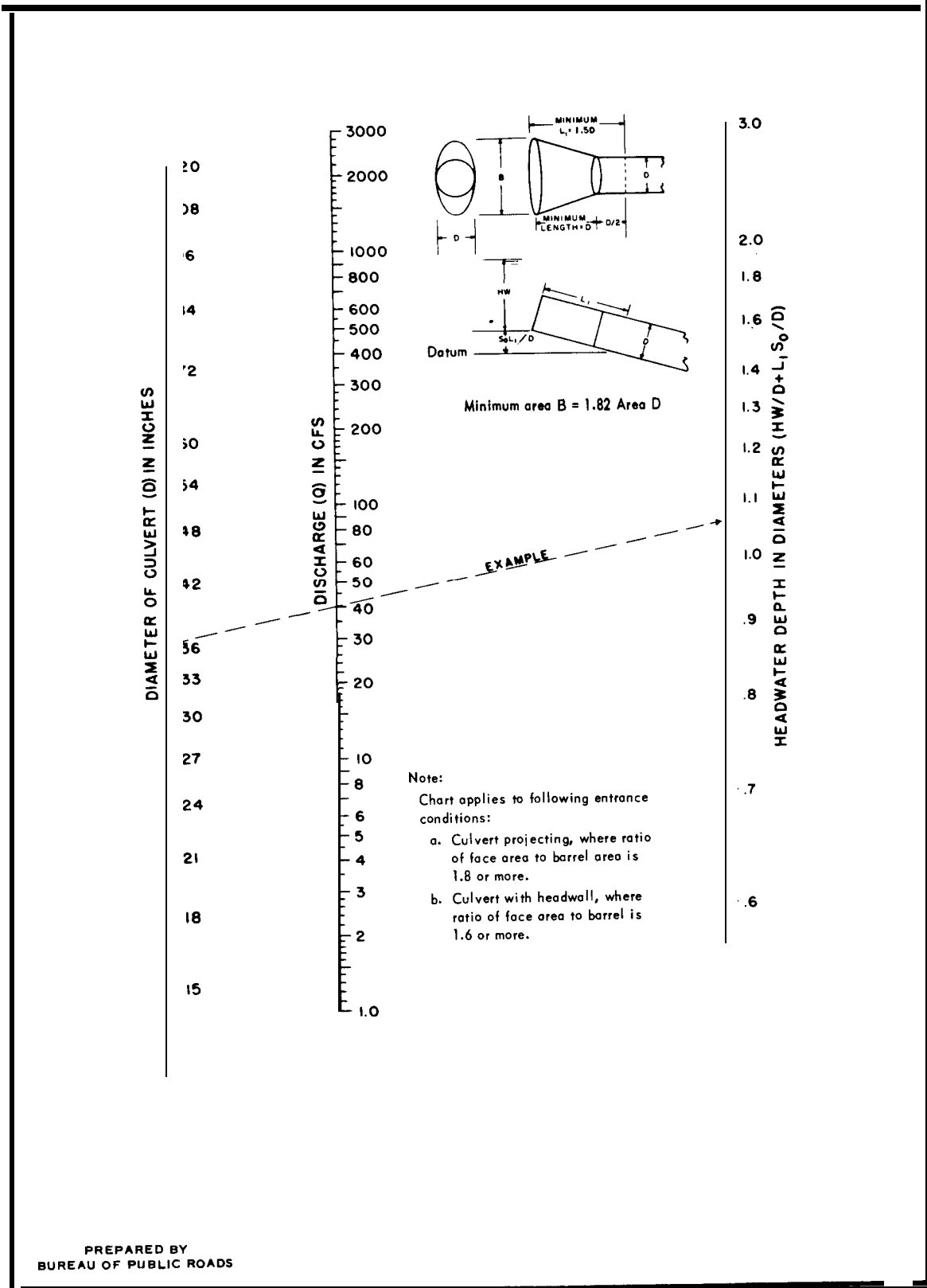

Figure B-8. Headwater depth for corrugated metal pipe culverts with tapered inlet-inlet control.

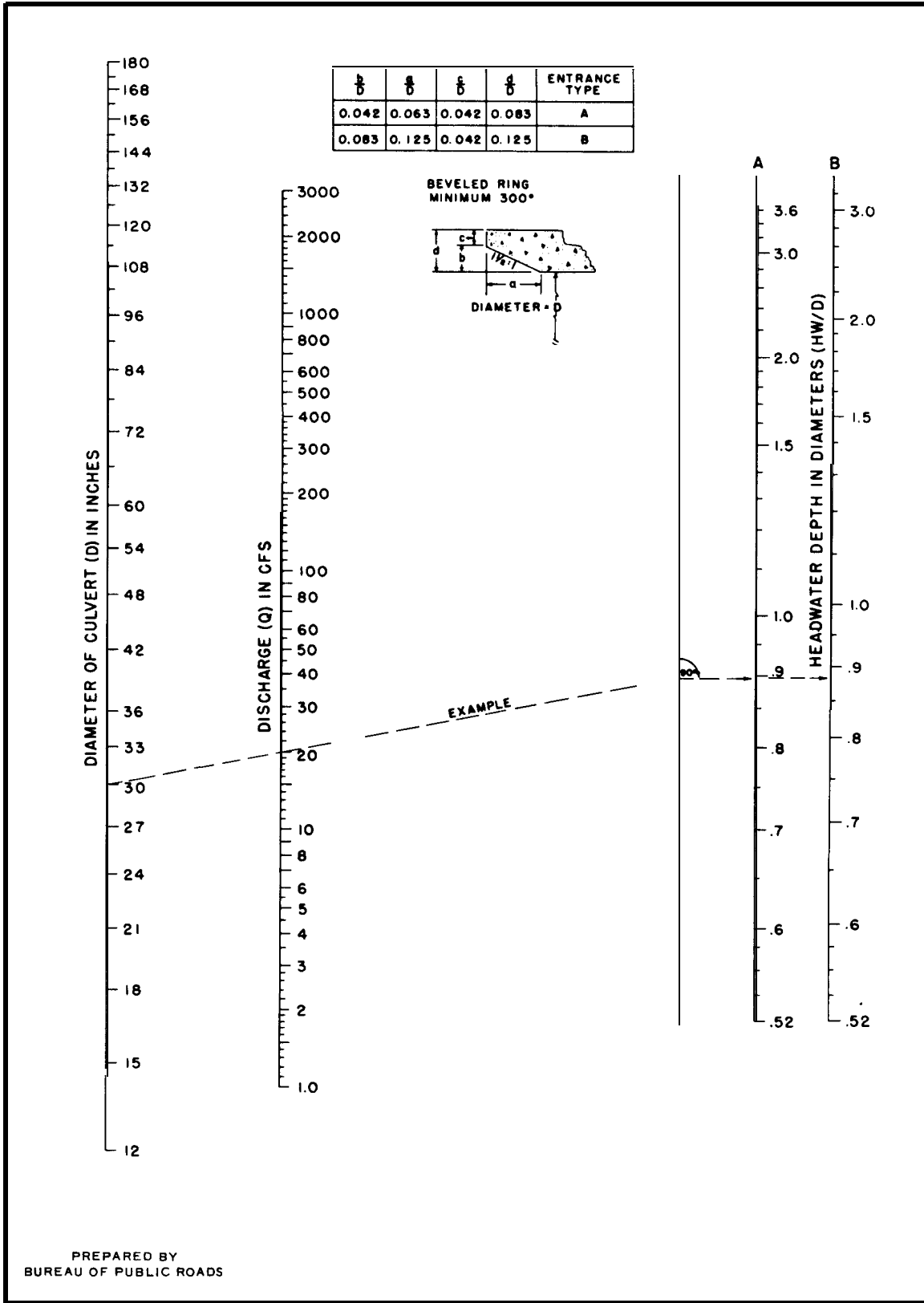
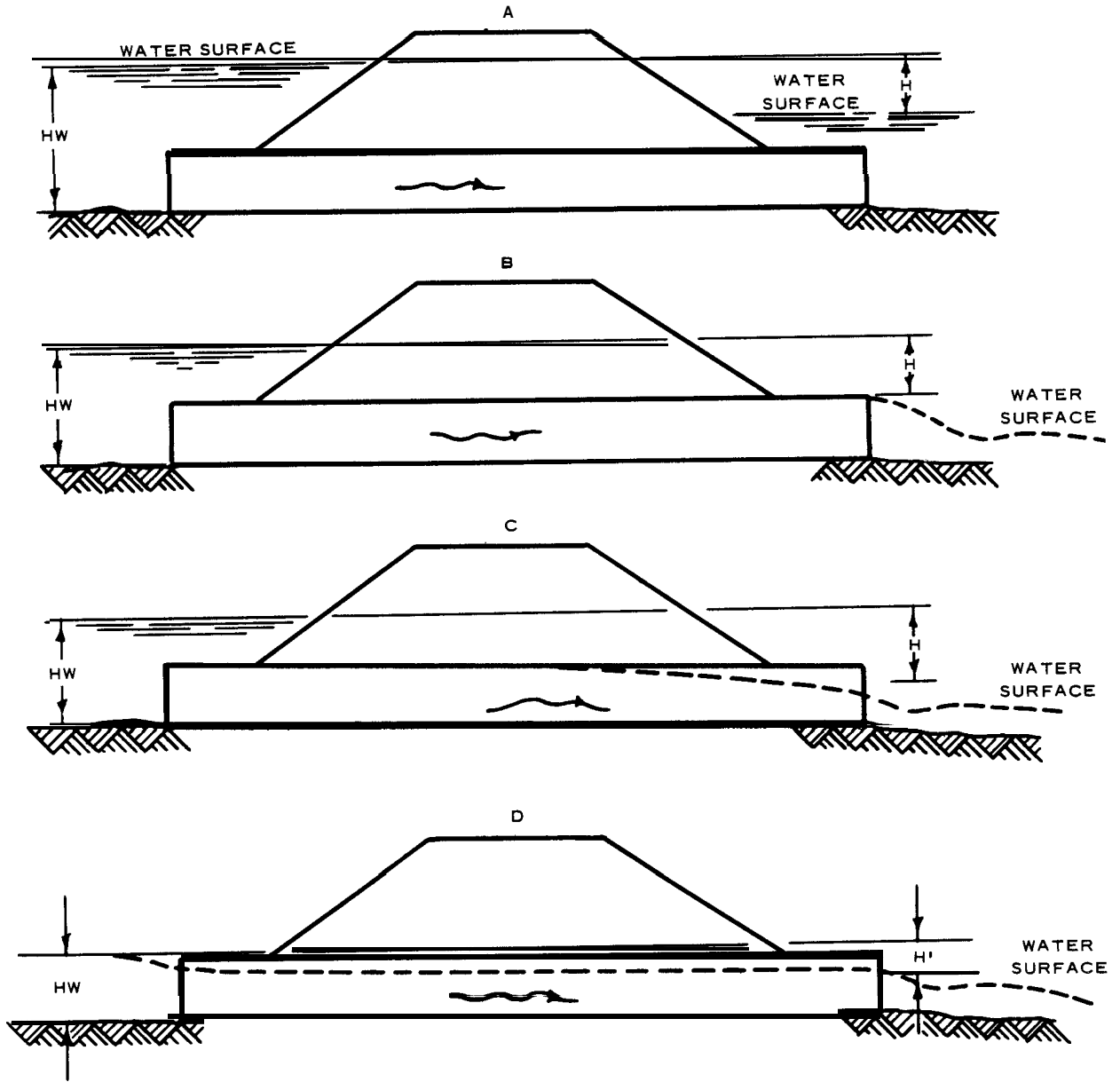

Figure B-9. Headwater depth for circular pipe culverts with beveled ring inlet control.



U. S. Army Corps of Engineers

Figure B-10. Outlet control.

Table B-1. Entrance Loss Coefficients
Outlet Control, Full or Partly Full

$$\text{Entrance head loss } H_e = K_e \frac{V^2}{2g}$$

| Type of Structure and Design of Entrance | Coefficient K_e |
|--|-------------------|
| <i>Pipe, Concrete</i> | |
| Projecting from fill, socket end (groove-end) | 0.2 |
| Projecting from fill, square-cut end | 0.5 |
| Headwall or headwall and wingwalls | |
| Socket end of pipe (groove-end) | 0.2 |
| Square-edge | 0.5 |
| Rounded (radius = 1/12D) | 0.2 |
| Mitered to conform to fill slope | 0.7 |
| *End Section conforming to fill slope | 0.5 |
| Beveled edges, 33.7° or 45° bevels | 0.2 |
| Side- or slope-tapered inlet | 0.2 |
| <i>Pipe, or Pipe-Arch, Corrugated Metal</i> | |
| Projecting from fill (no headwall) | 0.9 |
| Headwall or headwall and wingwalls, square-edge | 0.5 |
| Mitered to conform to fill slope, paved or unpaved slope | 0.7 |
| *End Section conforming to fill slope | 0.5 |
| Beveled edges, 33.7° or 45° bevels | 0.2 |
| Side- or slope-tapered inlet | 0.2 |
| <i>Box, Reinforced Concrete</i> | |
| Headwall parallel to embankment (no wingwalls) | |
| Square-edged on 3 edges | 0.5 |
| Rounded on 3 edges to radius of 1/12 barrel dimension, or beveled edges on 3 sides | 0.2 |
| Wingwalls at 30° to 75° to barrel | |
| Square-edged at crown | 0.4 |
| Crown edge rounded to radius of 1/12 barrel dimension, or beveled top edge | 0.2 |
| Wingwall at 10° to 25° to barrel | |
| Square-edged at crown | 0.5 |
| Wingwalls parallel (extension of sides) | |
| Square-edged at crown | 0.7 |
| Side- or slope-tapered inlet | 0.2 |
| *Note: "End Section conforming to fill slope," made of either metal or concrete, are the sections commonly available from manufacturers. From limited hydraulic tests they are equivalent in operation to a headwall in both <i>inlet</i> and <i>outlet</i> control. Some end sections, incorporating a <i>closed taper</i> in their design, have a superior hydraulic performance. These latter sections can be designed using the information given for the beveled inlet. | |

U.S. Army Corps of Engineers,

Variables in the equation are defined in appendix D.

Adding the three terms and simplifying, yields for full pipe, outlet control flow the following expression:

$$H = \left(1 + K_e + \frac{29n^2L}{R^{1.333}} \right) \left(\frac{V^2}{2g} \right) \quad \text{..... (1)}$$

This equation can be solved readily by the use of the full-flow nomography, figures B-II through B-17. The equations shown on these nomography are the same as equation 1 expressed in a different form. Each nomograph is drawn for a single value of n as noted in the respective figure. These nomography may be used for other

values of n by modifying the culvert length as directed in paragraph B-6, which describes use of the outlet-control nomography. The value of H must be measured from some "control" elevation at the outlet which is dependent on the rate of discharge or the elevation of the water surface of the tailwater. For simplicity, a value h_0 is used as the distance in feet from the culvert invert (flow line) at the outlet to the control elevation. The following equation is used to compute headwater in reference to the inlet invert:

$$HW = h_0 + H - LS_0 \quad \text{..... (2)}$$

b. Tailwater elevation at or above the top of the culvert barrel outlet (fig B-10A). The tailwater

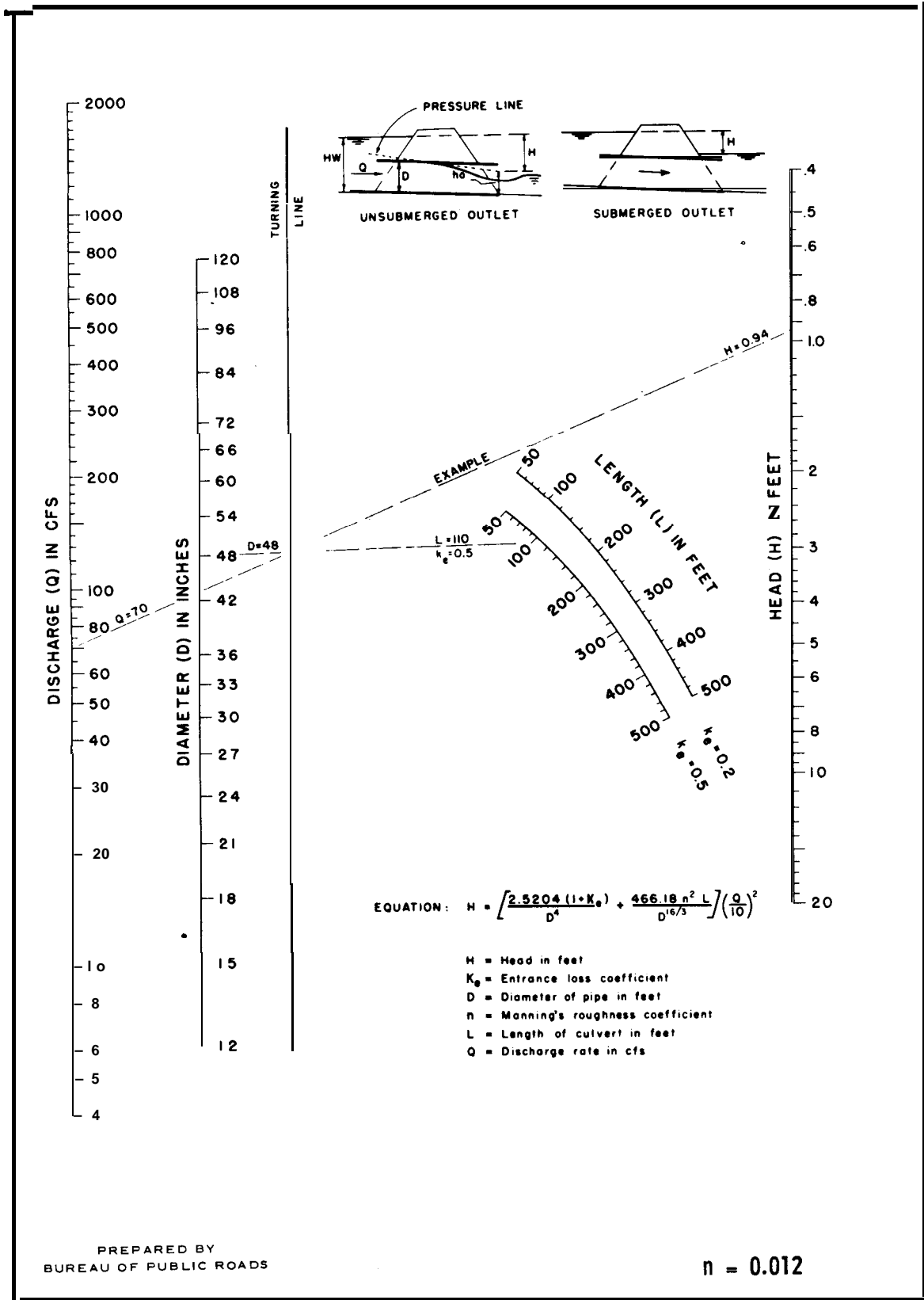

Figure B-11. Head for circular pipe culverts flowing full, n = 0.012.

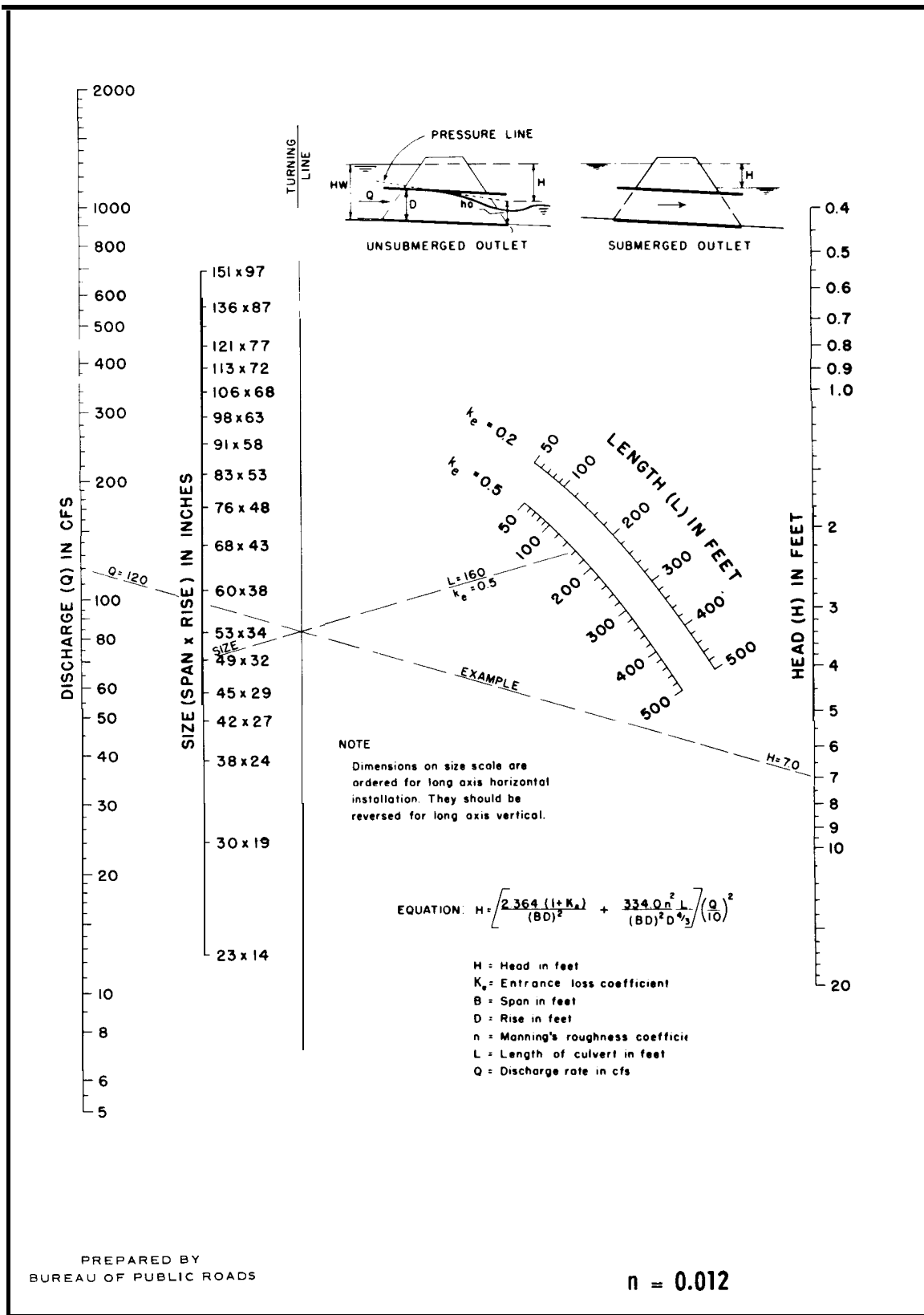

Figure B-12. Head for oval circular pipe culverts long axis horizontal or vertical flowing full, n = 0.012.

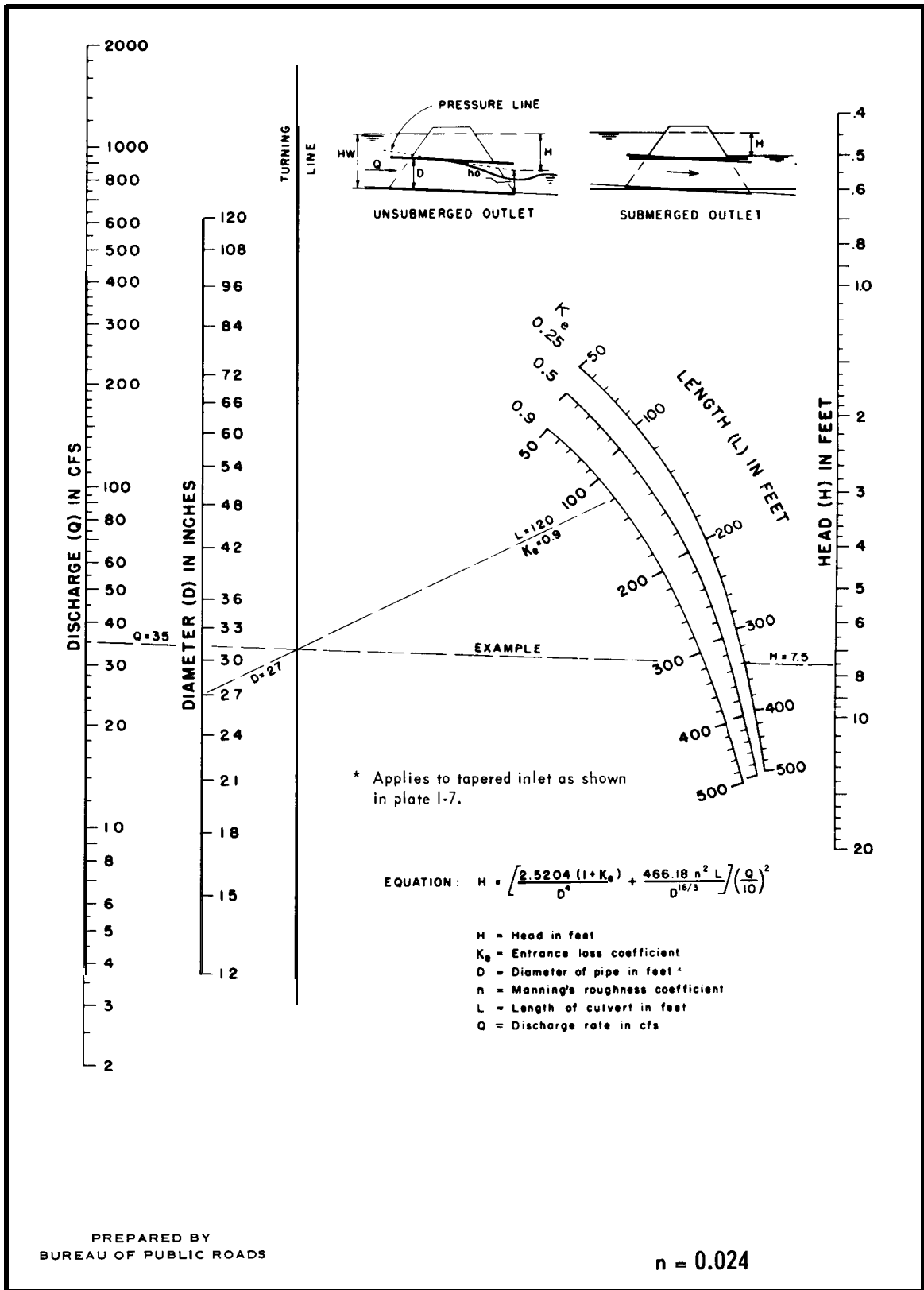

Figure B-13. Head for circular pipe culverts flowing full, n = 0.024.

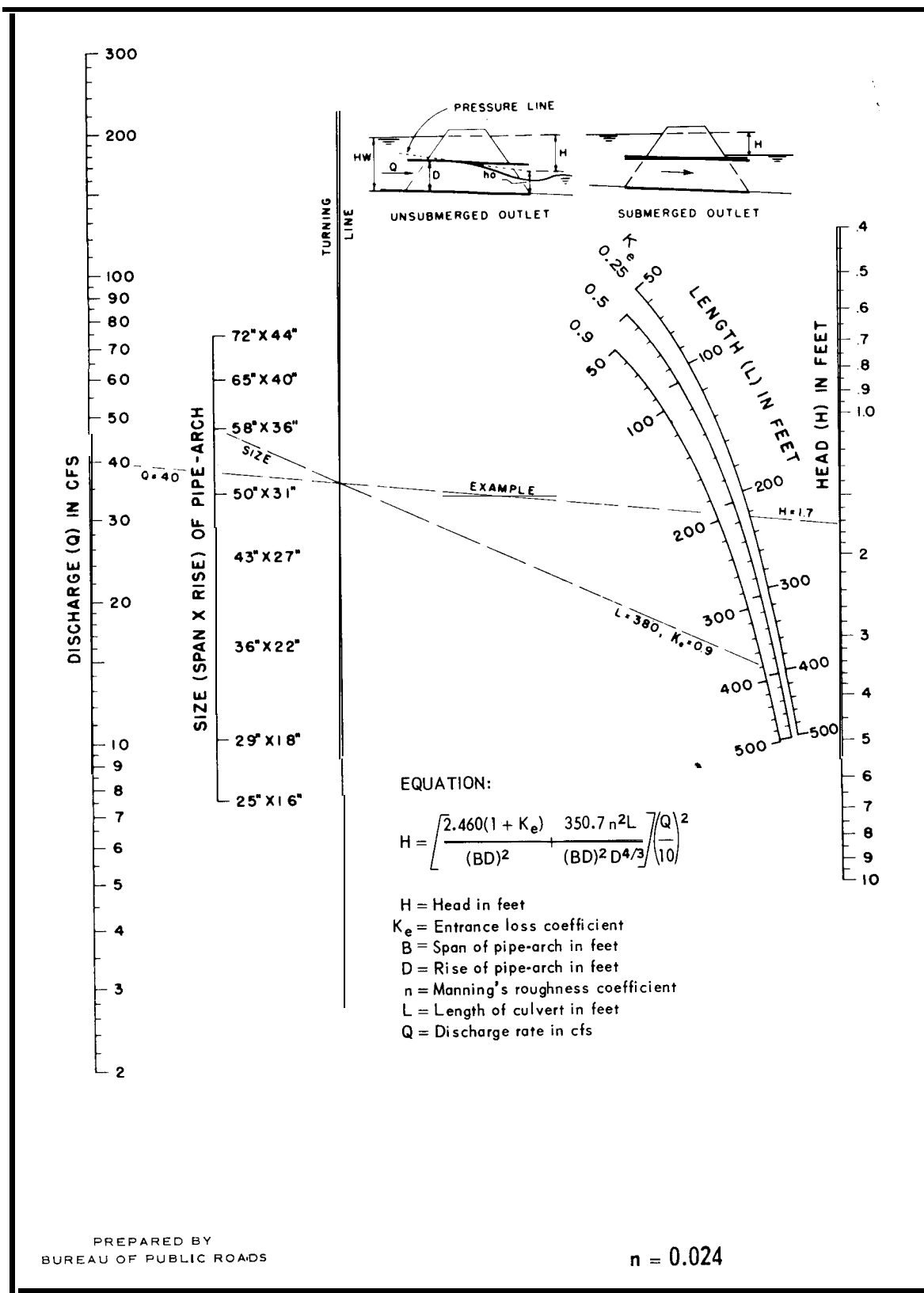

Figure B-15. Head for standard corrugated metal pipe-arch culverts flowing full, n = 0.024.

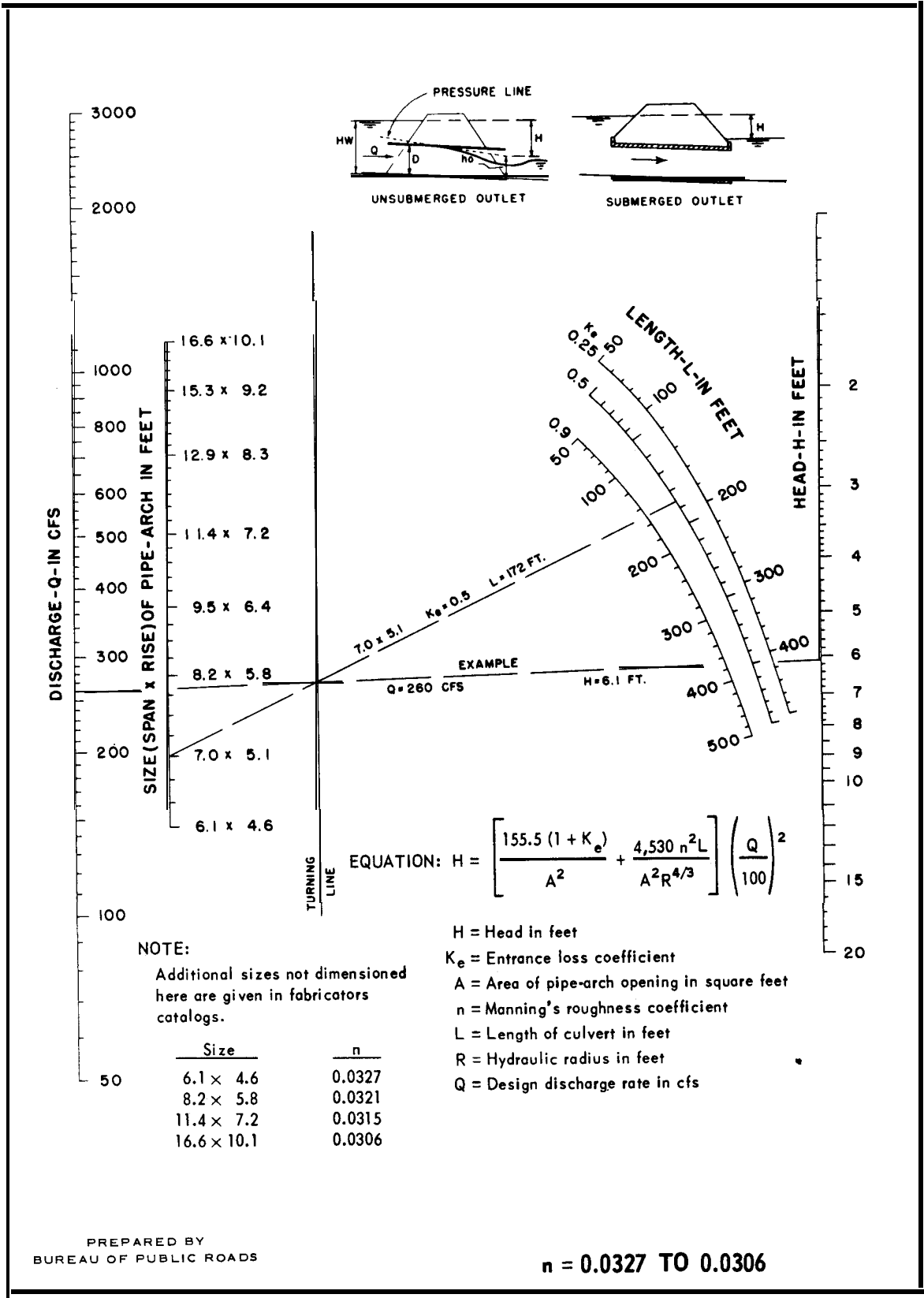

Figure B-16. Head for field-bolted structural plate pipe-arch culverts 18-in. corner radius flowing full, n = 0.0327 to 0.0306.

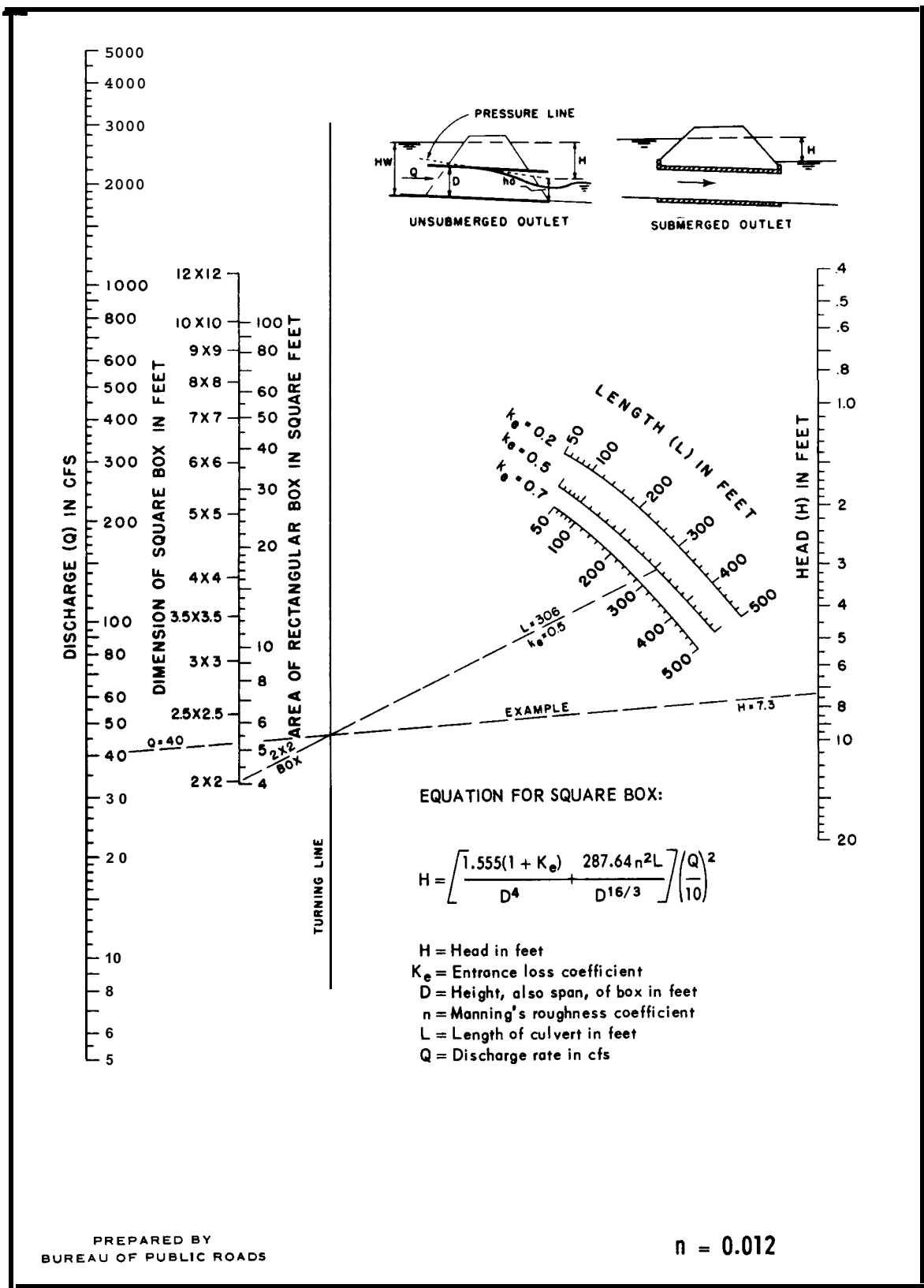

Figure B-17. Head for concrete box culverts flowing full, n = 0.012.

(TW) depth is equal to h_0 , and the relation of headwater to other terms in equation 2 is illustrated in figure B-18.

c. *Tailwater elevation below the top or crown of the culvert barrel outlet.* Figure B-10B, C, and D are three common types of flow for outlet control with this low tailwater condition. In these cases h_0 is found by comparing two values, TW depth in the outlet channel and $\frac{d_c + D}{2}$, and setting h_0

equal to the larger value. The fraction $\frac{d_c + D}{2}$ is a simplified mean of computing h_0 when the tailwater is low and the discharge does not fill the culvert barrel at the outlet. In this fraction, d_c is critical depth as determined from figures B-18 through B-23 and D is the culvert height. The value of DC should never exceed D, making the upper limit of this fraction equal to D. Figure B-19 shows the terms of equation 2 for the cases discussed above. Equation 2 gives accurate answers if the culvert flows full for a part of the barrel length as illustrated by figure B-23. This condition of flow will exist if the headwater, as determined by equation 2, is equal to or greater than the quantity:

$$HW \geq D + (1 + K_e) \frac{V^2}{2g}$$

If the headwater drops below this point the water surface will be free throughout the culvert barrel as in figure B-10D, and equation 2 yields answers with some error since the only correct method of finding headwater in this case is by a backwater computation starting at the culvert

outlet. However, equation 2 will give answers of sufficient accuracy for design purposes if the headwater is limited to values greater than 0.75D. H' is used in figure B-10D to show that the head loss here is an approximation of H. No solution is given for headwater less than 0.75D. The depth of tailwater is important in determining the hydraulic capacity of culverts flowing with outlet control. In many cases the downstream channel is of considerable width and the depth of water in the natural channel is less than the height of water in the outlet end of the culvert barrel, making the tailwater ineffective as a control, so that its depth need not be computed to determine culvert discharge capacity or headwater. There are instances, however, where the downstream water-surface elevation is controlled by a downstream obstruction or backwater from another stream. A field inspection of all major culvert locations should be made to evaluate downstream controls and determine water stages. An approximation of the depth of flow in a natural stream (outlet channel) can be made by using Manning's equation, $V = \frac{1.486}{n} R^{2/3} S^{1/2}$, if the

channel is reasonably uniform in cross section, slope, and roughness. Values of n for natural streams in Manning's formula are given in table B-2. If the water surface in the outlet channel is established by downstream controls other means must be found to determine the tailwater elevation. Sometimes this necessitates a study of the stage-discharge relation of another stream into which the stream in question flows or the securing of data on reservoir elevations if a storage dam is involved.

Table B-2. Manning's n for Natural Stream Channels
(Surface width at flood stage less than 100 feet)

| | |
|---|-------------|
| Fairly regular section: | |
| Some grass and weeds, little or no brush ----- | 0.030-0.035 |
| Dense growth of weeds, depth of flow materially greater than weed height ----- | 0.035-0.05 |
| Some weeds, light brush on banks ----- | 0.035-0.05 |
| Some weeds, heavy brush on banks ----- | 0.05-0.07 |
| Some weeds, dense willows on banks ----- | 0.06-0.08 |
| For trees within channel, with <i>branches</i> submerged at high stage, increase all above values by ----- | 0.01-0.02 |
| Irregular sections, with pools, slight channel meander; increase values given above about ----- | 0.01-0.02 |
| Mountain streams, no vegetation in channel, banks usually steep, trees and brush along banks submerged at high stage: | |
| Bottom of gravel, cobbles, and few boulders ----- | 0.04-0.05 |
| Bottom of cobbles, with <i>large</i> boulders ----- | 0.05-0.07 |

U.S. Army Corps of Engineers

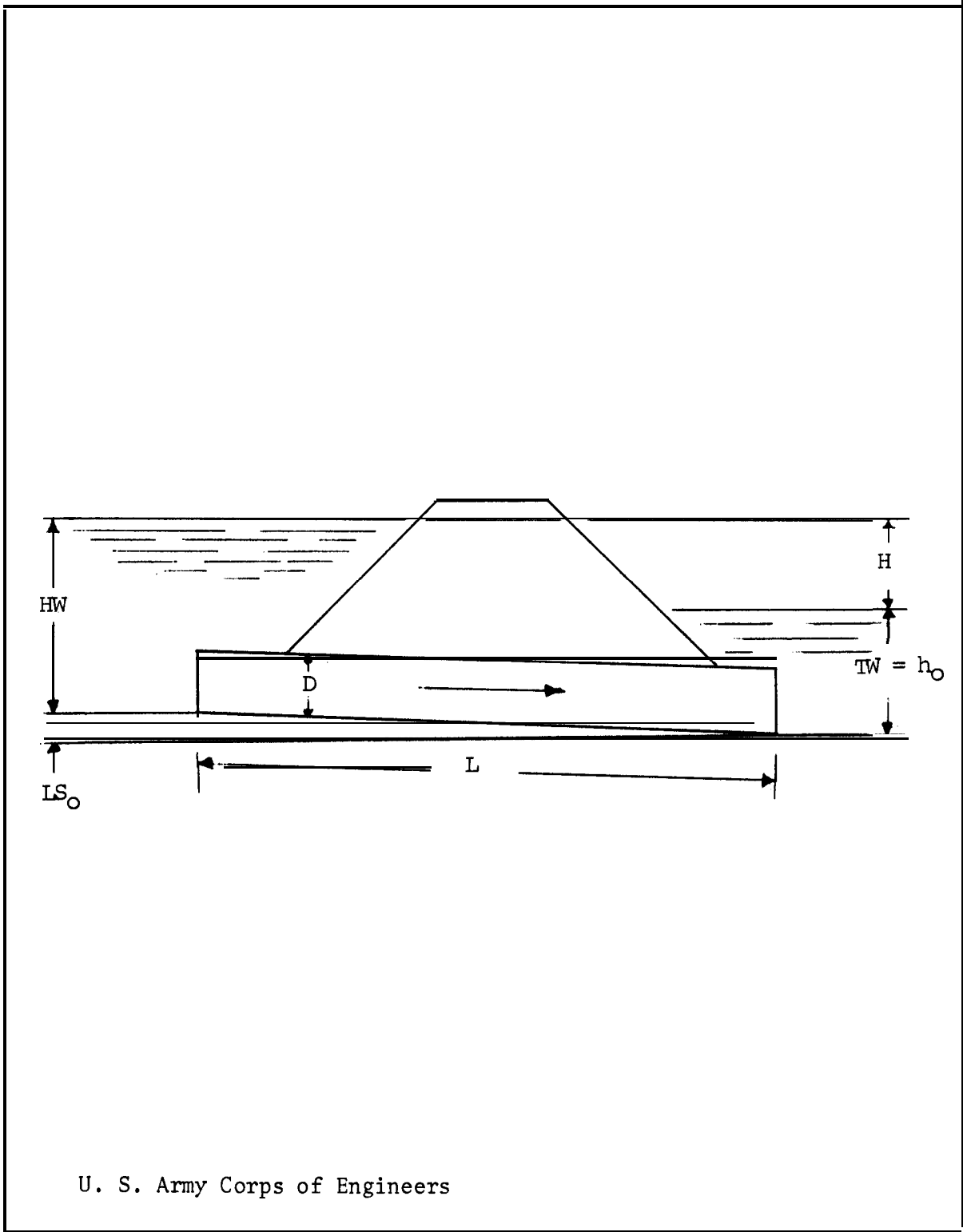

Figure B-18, Tailgate elevation at or above top of culved.

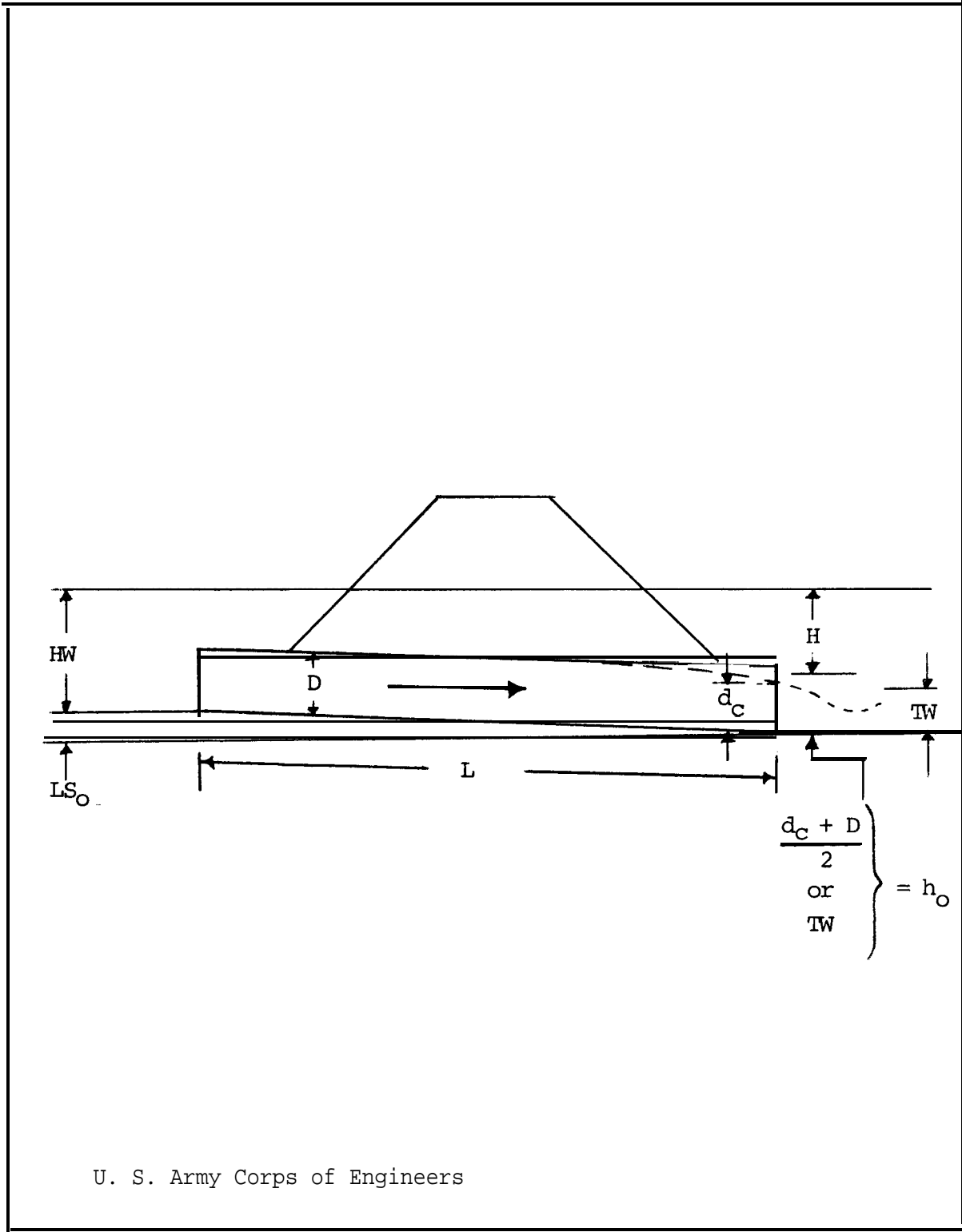

Figure B-19. Tailwater below the top of the culvert.

B-4. Procedure for selection of culvert size.

Select the culvert size by the following steps:

Step 1: List given data.

- Design discharge, Q , in cubic feet per second.
- Approximate length of culvert, in feet.
- Allowable headwater depth, in feet, which is the vertical distance from the culvert invert (flow line) at entrance to the water-surface elevation permissible in the approach channel upstream from the culvert.
- Type of culvert, including barrel material, barrel cross-sectional shape, and entrance type.
- Slope of culvert. (If grade is given in percent, convert to slope in feet per foot.)
- Allowable outlet velocity (if scour is a problem).

Step 2: Determine a trial-size culvert.

- Refer to the inlet-control nomograph (figs B-2 through B-9) for the culvert type selected
- Using an $\frac{HW}{D}$ of approximately 1.5 and the scale for the entrance type to be used, find a trial-size culvert by following the instructions for use of these nomographs. If reasons for lesser or greater relative depth of headwater in a particular case should exist, another value of $\frac{HW}{D}$ may be used for this trial selection.
- If the trial size for the culverts is obviously too large because of limited height of embankment or availability of size, try a $\frac{HW}{D}$ value or multiple culverts by dividing the discharge equally for the number of culverts used. Raising the embankment height or using pipe arch and box culverts with width greater than height should be considered. Selection should be based on an economic analysis.

Step 3: Find headwater depth for the trial-size culvert.

- Determine and record headwater depth by use of the appropriate inlet-control nomograph (figs B-2 through B-9). Tailwater conditions are to be neglected in this determination. Headwater in this case is found by simply multiplying $\frac{HW}{D}$ obtained from the nomograph by D .

b. Compute and record headwater for outlet control as instructed below:

- Approximate the depth of tailwater for the design flood condition in the outlet channel. The tailwater depth may also be due to backwater caused by another stream or some control downstream.
- For tailwater depths equal to or above the depth of the culvert at the outlet, set tailwater equal to h_o and find headwater by the following equation:

$$HW = h_o + H - S_oL$$

- For tailwater elevations below the crown of culvert at the outlet, use the following equation to find headwater:

$$HW = h_o + H - S_oL$$

where $h_o = \frac{d_c + D}{2}$ or TW, whichever

is greater. When d_c (figs B-20 through B-25) exceeds rectangular section, h_o should be set equal to D .

- Compare the headwater found in Step 3a and Step 3b (inlet control and outlet control). The higher headwater governs and indicates the flow control existing under the given conditions.
- Compare the higher headwater above with that allowable at the site. If headwater is greater than allowable, repeat the procedure using a larger culvert. If headwater is less than allowable, repeat the procedure to investigate the possibility of using a smaller size.

Step 4: Check outlet velocities for size selected.

- If outlet control governs in Step 3c, outlet velocity equals Q/A , where A is the cross-sectional area of flow at the outlet. If d_c or TW is less than the height of the culvert barrel, use cross-sectional area corresponding to d_c or TW depth, whichever gives the greater area of flow.
- If inlet control governs in Step 3c, outlet velocity can be assumed to equal normal velocity in open-channel flow as computed by Manning's equation for the barrel size, roughness, and slope of culvert selected.

Step 5: Try a culvert of another type or shape and determine size and headwater by the above procedure.

Step 6: Record final selection of culvert with size, type, outlet velocity, required headwater, and economic justification.

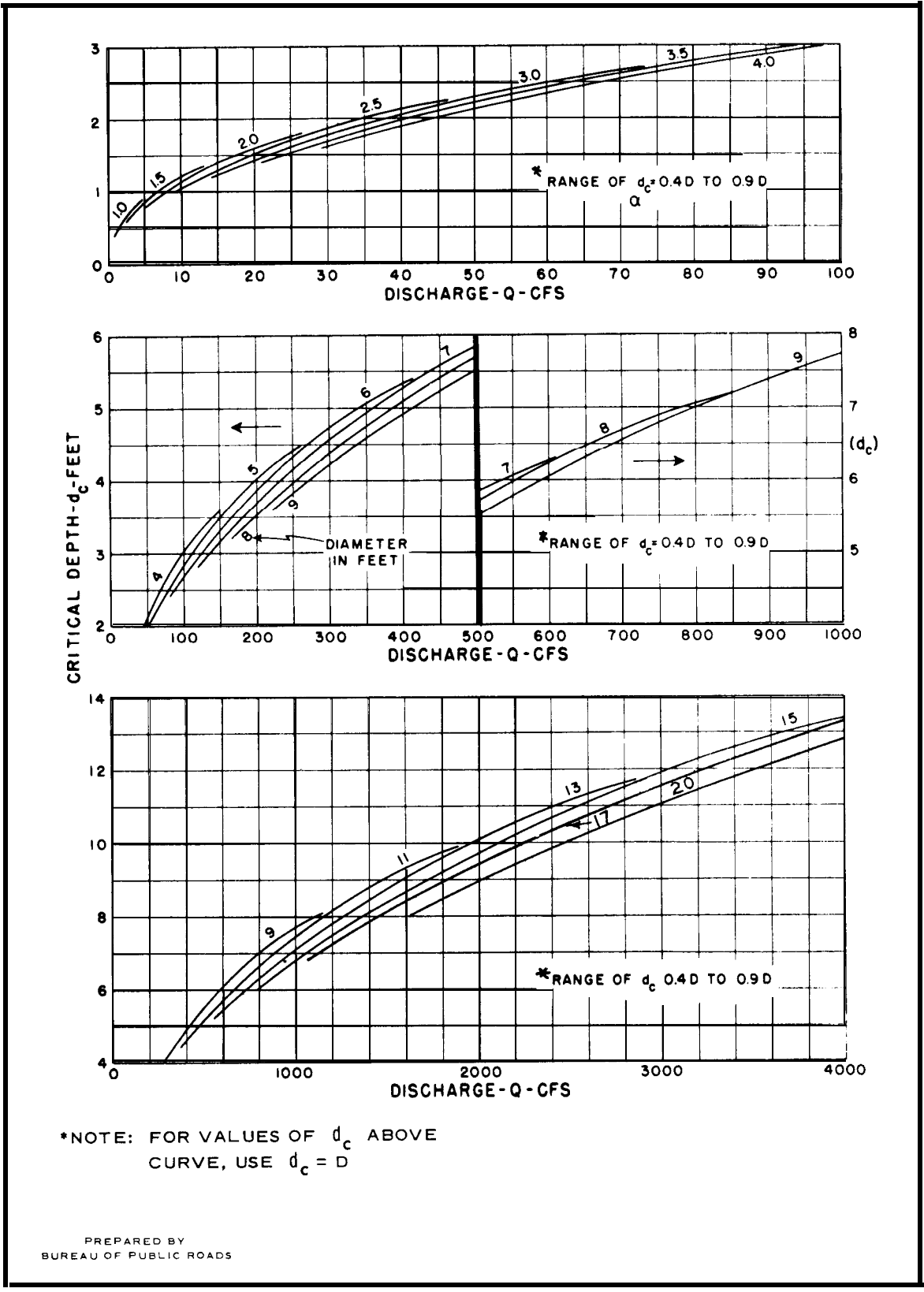

Figure B-20. Circular pipe—critical depth.

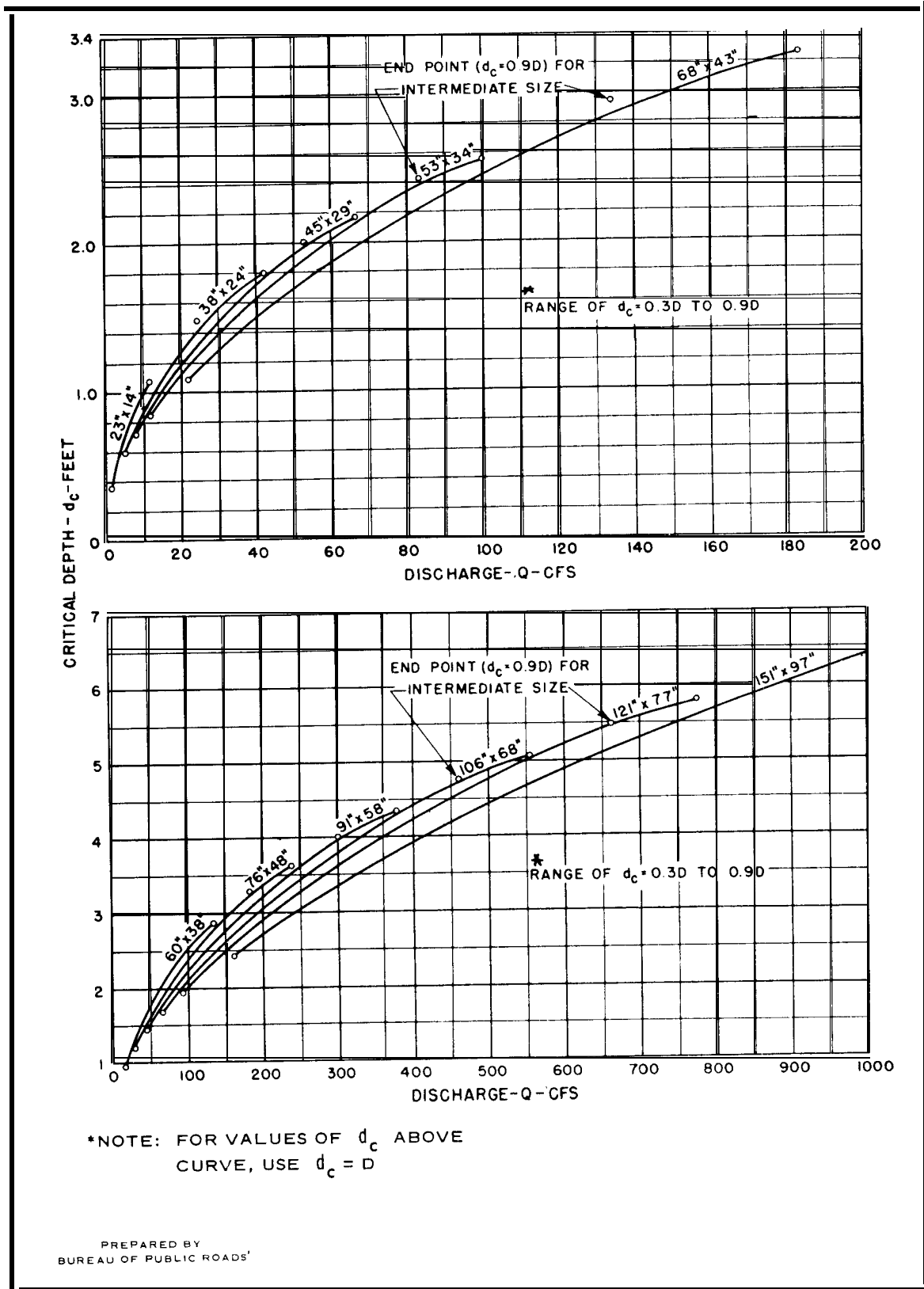
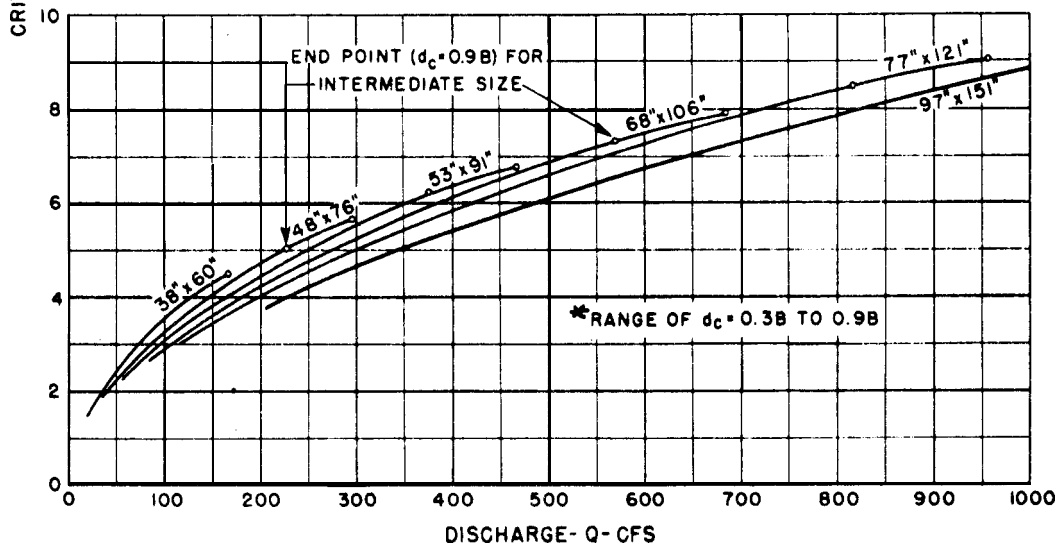
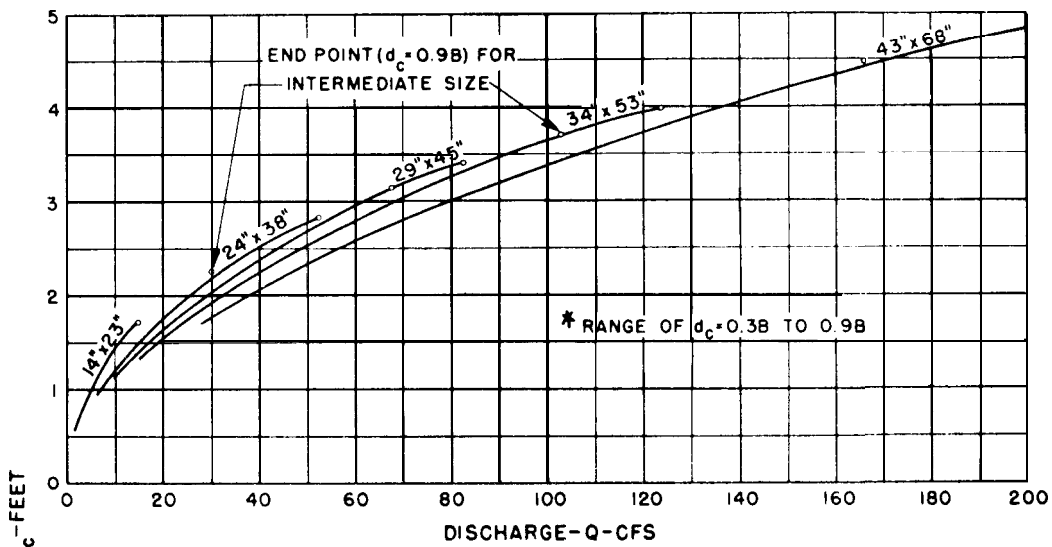

Figure B-21. Oval concrete pipe long axis horizontal critical depth.



*NOTE: FOR VALUES OF d_c ABOVE CURVE, USE $d_c = D$

PREPARED BY
BUREAU OF PUBLIC ROADS

Figure B-22. Oval concrete pipe long axis vertical critical depth.

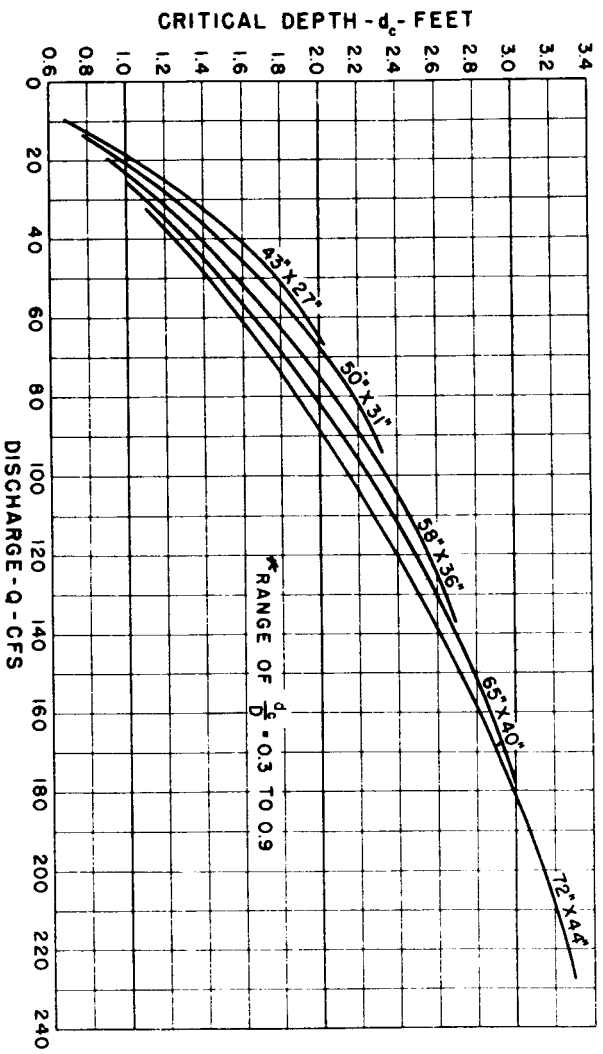
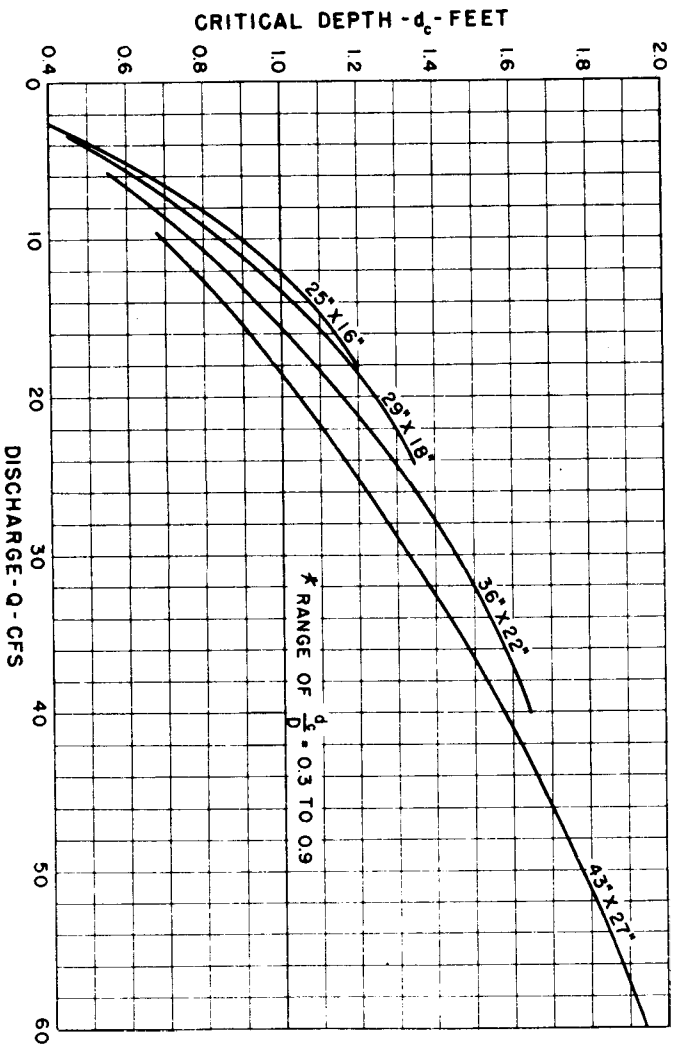

*NOTE: FOR VALUES OF d_c ABOVE
CURVE, USE $d_c = D$

PREPARED BY
BUREAU OF PUBLIC ROADS

Figure B-28. Standard corrugated metal pipe-arch critical depth.

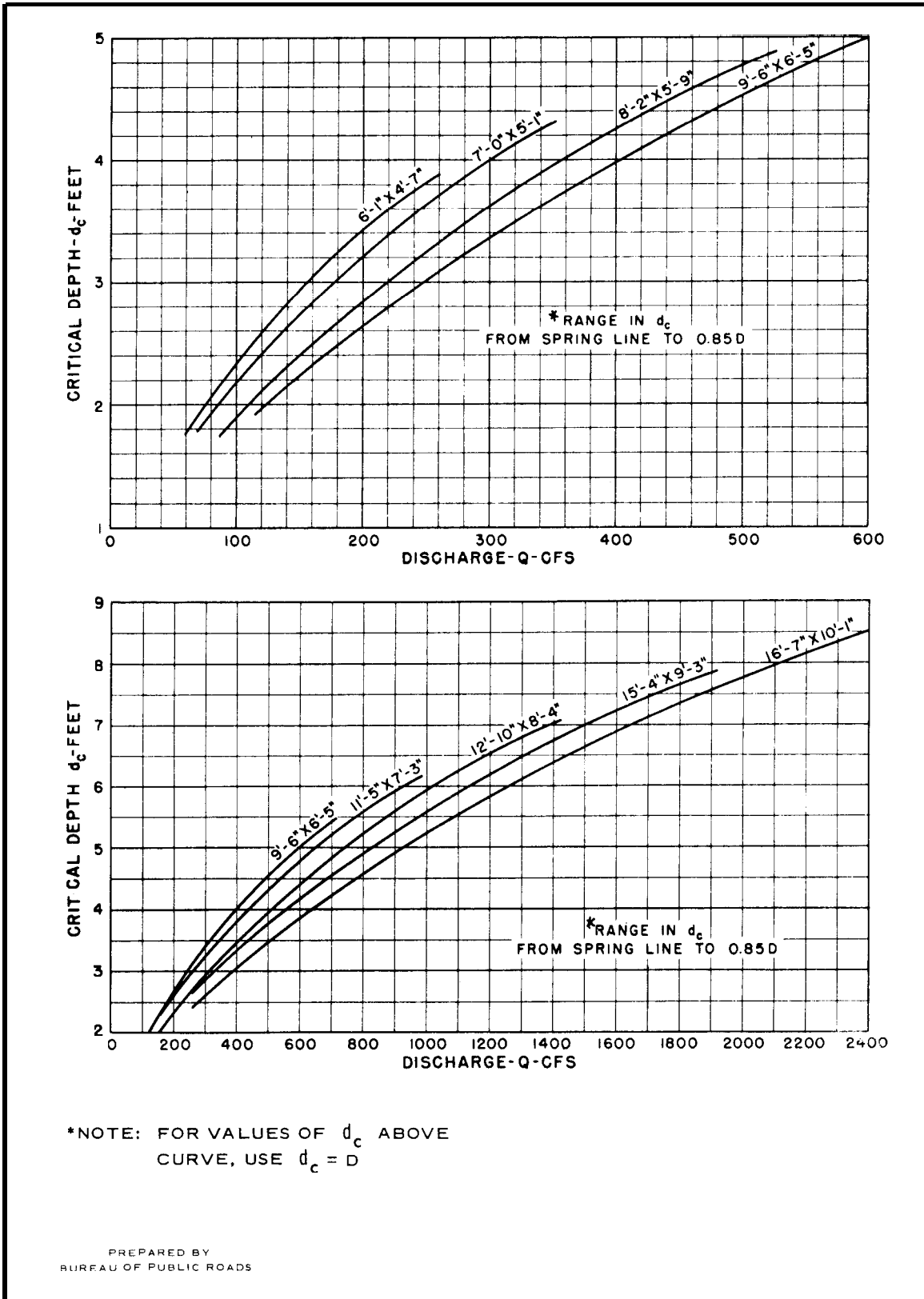

Figure B-24. Structural plate pipe-arch critical depth.

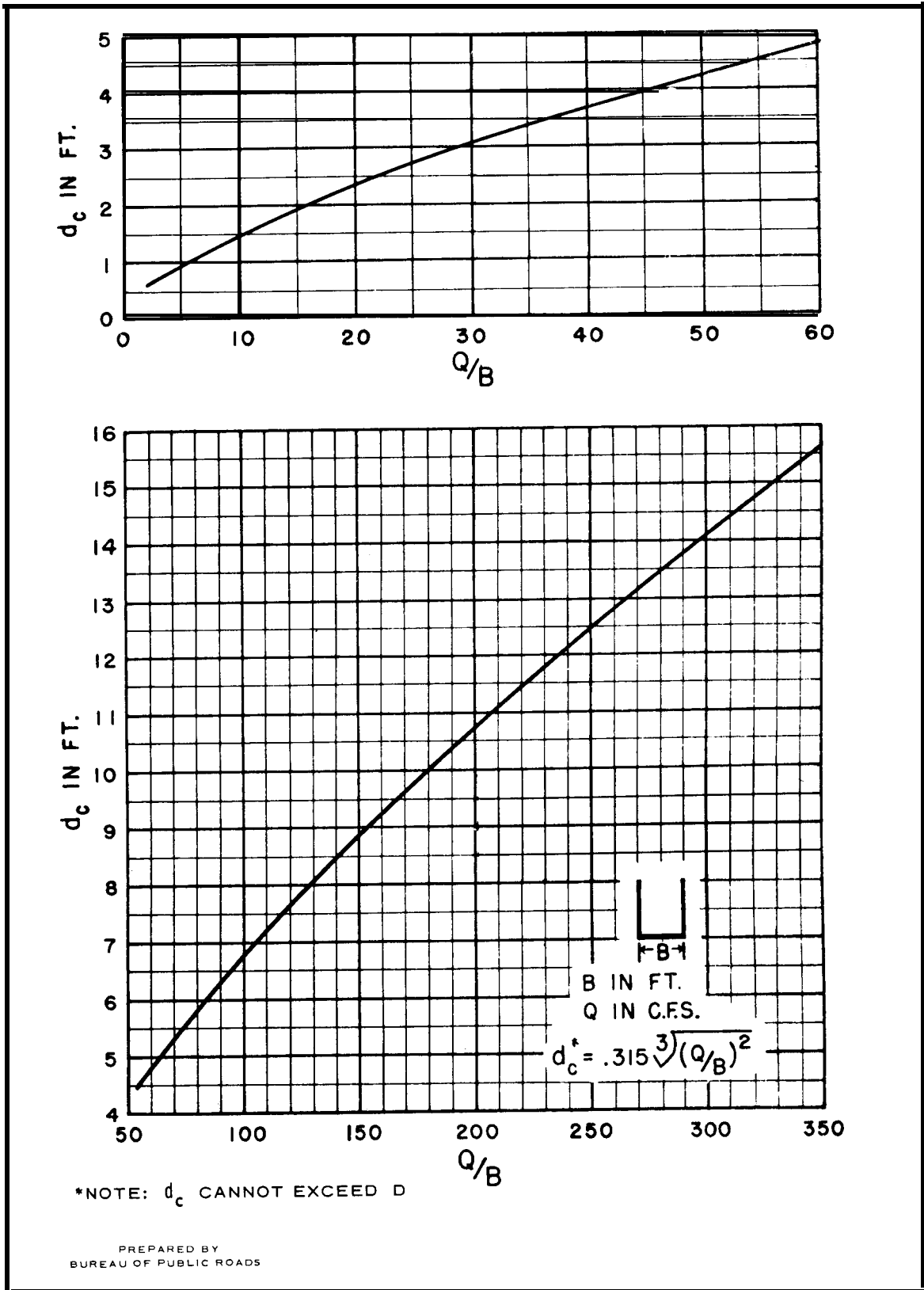

Figure B-25. Critical depth rectangular section.

B-5. Instructions for use of inlet-control nomographs (figs B-2 through B-9).

a. To determine headwater.

- (1) Connect with a straight edge the given culvert diameter or height, D , and the discharge, Q , or Q/B for box culverts; mark intersection of straight edge on $\frac{HW}{D}$ scale 1.
- (2) If $\frac{HW}{D}$ scale 1 represents entrance type used, read $\frac{HW}{D}$ on scale 1. If some other entrance type is used extend the point of intersection ((1) above) horizontally to scale 2 or 3 and read $\frac{HW}{D}$.
- (3) Compute headwater by multiplying $\frac{HW}{D}$ by D .

b. To determine culvert size.

- (1) Given an $\frac{HW}{D}$ value, locate $\frac{HW}{D}$ on scale for appropriate entrance type. If scale 2 or 3 is used, extend $\frac{HW}{D}$ point horizontally to scale 1.
- (2) Connect point on $\frac{HW}{D}$ scale 1 as found in (1) above to given discharge and read diameter, height, or size of culvert required.

c. To determine discharge.

- (1) Given HW and D , locate $\frac{HW}{D}$ on scale for appropriate entrance type. Continue as in b(1) above.
- (2) Connect point on $\frac{HW}{D}$ scale 1 as found in (1) above and the size of culvert on the left scale and read Q or Q/B on the discharge scale.
- (3) If Q/B is read multiply by B to find Q .

B-6. Instruction for use of outlet-control nomography.

a. Figures B-n through B-17 are nomography to solve for head when culverts flow full with outlet control. They are also used in approximating the head for some partially full flow conditions with outlet control. These nomography do not give a complete solution for finding headwater. (See para B-4.)

- (1) Locate appropriate nomograph for type of culvert selected.
- (2) Begin nomograph solution by locating starting point on length scale. To locate the proper starting point on the length scale, follow instructions below:
 - (a) If the n value of the nomograph corresponds to that of the culvert being used, find the proper K_e from table B-1 and on the appropriate nomograph locate starting point on length curve for the K_e . If a K_e curve is not shown for the selected K_e , and (b) below. If the n value for the culvert selected differs from that of the nomograph, see (c) below.
 - (b) For the n of the nomograph and a K_e intermediate between the scales given, connect the given length on adjacent scales by a straight line and select a point on this line spaced between the two chart scales in proportion to the K_e values.
 - (c) For a different value of roughness coefficient n_1 than that of the chart n , use the length scales shown with an adjusted length L_1 , calculated by the formula:

$$L_1 = L \left(\frac{n_1}{n} \right)^2$$

(See subpara *b* below for n values.)

- (3) Using a straight edge, connect point on length scale to size of culvert barrel and mark the point of crossing on the "turning line." See instruction *c* below for size considerations for rectangular box culvert.
- (4) Pivot the straight edge on this point on the turning line and-connect given discharge rate. Read head in feet on the head scale. For values beyond the limit of the chart scales, find H by solving equation given in nomograph or by $H = KQ^2$ where K is found by substituting values of H and Q from chart.

b. Table B-3 is used to find the n value for the culvert selected.

c. To use the box-culvert nomograph (fig B-17) for full flow for other than square boxes:

- (1) Compute cross-sectional area of the rectangular box.

Note: The area scale on the nomograph is calculated for barrel cross sections with span B twice the height D ; its close correspondence with area of square boxes assures it may be used for all sections intermediate between square and $B = 2D$ or $B = 2/3D$. For other box proportions use equation shown in nomograph for more accurate results.

Table B-3. Roughness Coefficients for Various Pipes

$n = 0.012$ for smooth interior pipes of any size, shape or type*

n Value for Annular Corrugated Metal

| <u>Corrugation Size</u> | <u>Unpaved</u> | <u>25% Paved</u> |
|-------------------------|----------------|------------------|
| 2½ by ½ inch | 0.024 | 0.021 |
| 3 by 1 inch | 0.027 | 0.023 |
| 6 by 2 inch | 0.028-0.033 | 0.024-0.028 |
| 9 by 2½ inch | 0.033 | 0.028 |

n Values for helical corrugated metal (2½ by ½ inch corrugations)

| <u>Pipe Diameter</u> | <u>Unpaved</u> | <u>25% Paved</u> |
|----------------------|----------------|------------------|
| 12-18 inches | 0.011-0.014 | * |
| 24-30 inches | 0.016-0.018 | 0.015-0.016 |
| 36-96 inches | 0.019-0.024 | 0.017-0.021 |

*Includes asbestos cement, bituminized fiber, cast iron, clay, concrete (precast or cast-in-place) or fully paved (smooth interior) corrugated metal pipe.

U.S. Army Corps of Engineers

• **NOTE: Limitations helical coefficient** - The designer must assure that fully developed spiral flow can occur in his design situation before selecting the lower resistance factor. Fully developed spiral flow, and the corresponding lower resistance factors, can only occur when the conduit flows full. For conduits shorter than 20 diameters long, it is felt that the full development of spiral flow cannot be assured. Bed load deposition on the culvert invert may hinder the development of spiral flow until sediment is washed out. When these conditions exist, the resistance factors for annular C.M .P. of the same size and corrugation shape should be used.

- (2) Connect proper point (see para B-6b) on length scale to barrel area and mark point on turning line.
- (3) Pivot the straight edge on this point on the turning line and connect given discharge rate. Read head in feet on the head scale.

B-7. Culvert capacity charts. Figures B-26 through B-43, prepared by the Bureau of Public Roads, present headwater discharge relations convenient for use in design of culverts of the most common types and sizes. The solid-line curve for each type and size represents for a given length: slope ratio the culvert capacity with control at the inlet; these curves are based generally on model data. For those culvert types for which a dashed-line curve is shown in addition to a solid-line curve, the dashed line represents for a given length: slope ratio the discharge capacity for free flow and control at the outlet; these curves are based on experimental data and backwater computations. The length: slope ratio is **L/100 S_o given on the solid line curve and in each case is the value at which the discharge with outlet**

control equals the discharge with inlet control. For culverts with free flow and control at the outlet, **interpolation and extrapolation for different L/100S_o** values is permitted in the range of headwater depths equal to or less than twice the barrel height. The upper limit of this range of headwater depths is designated by a horizontal dotted line on the charts. **Values of L/100 S_o less than those given in the chart** do not impose any limitation; merely read the solid-line curves. The symbol AHW means allowable headwater depth. The charts permit rapid selection of a culvert size to meet a given headwater limitation for various entrance conditions and types and shapes of pipe. One can enter with a given discharge and read vertically upward to the pipe size that will carry the flow to satisfy the headwater limitation of the design criteria. The major restriction on the use of the charts is that free flow must exist at the outlet. In most culvert installations free flow exists, i.e., flow passes through critical depth near the culvert outlet. For submerged flow conditions the solution can be obtained by use of the outlet control nomographs.

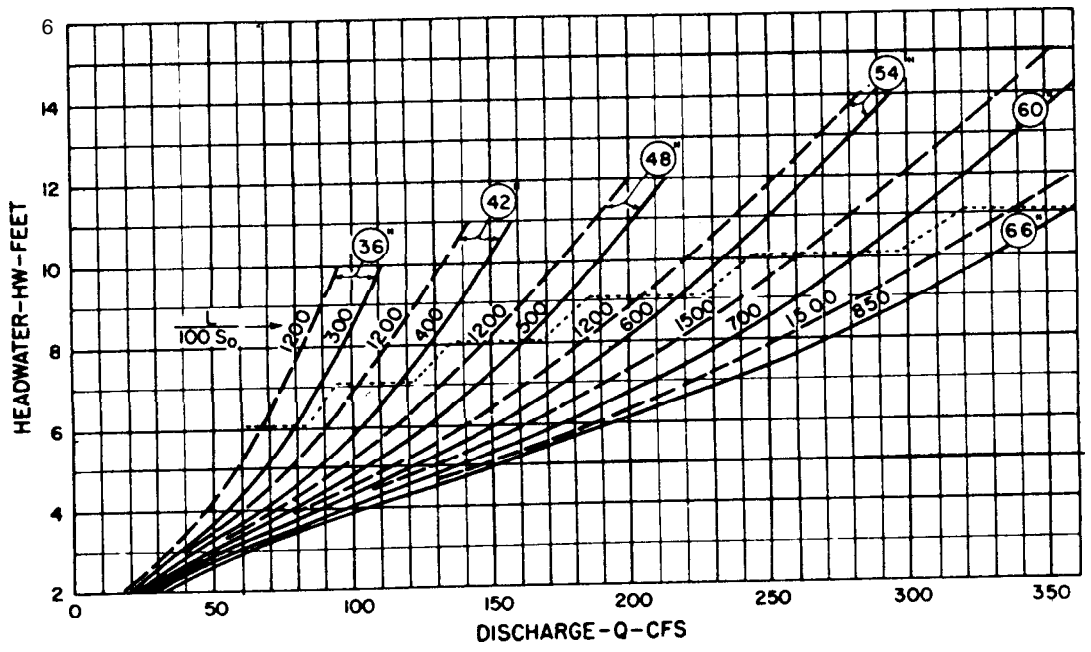
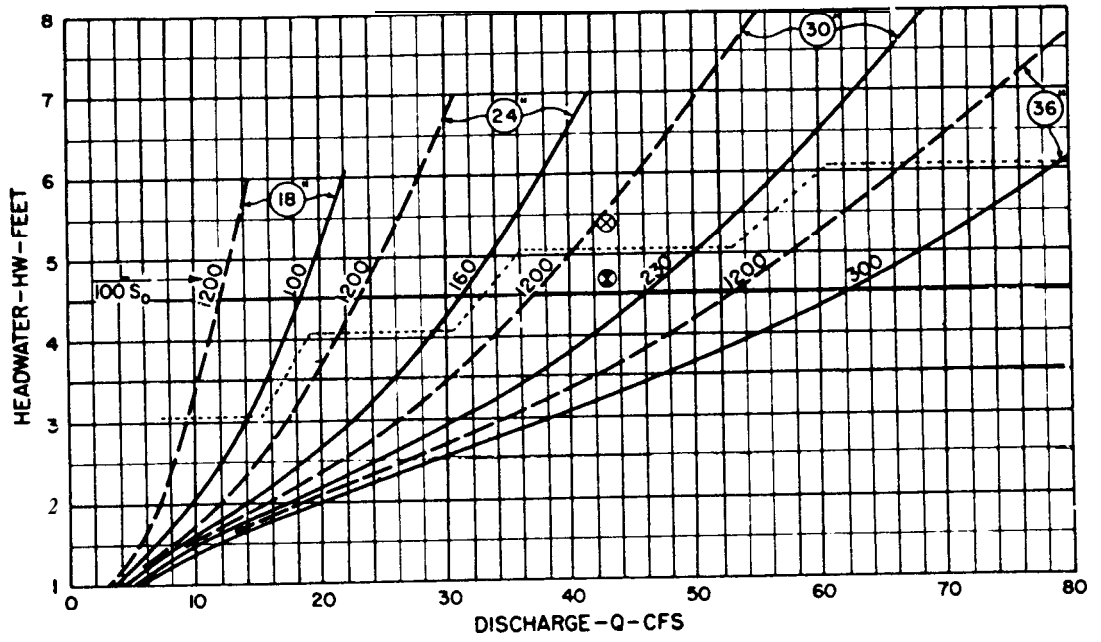

EXAMPLE
 ⊗ GIVEN:
 43 CFS ; AHW = 5.4 FT.
 L = 120 FT. ; S₀ = 0.002
 ● SELECT 30"
 HW = 4.7 FT.

BUREAU OF PUBLIC ROADS JAN. 1963

Figure B-26. Culvert capacity circular concrete pipe groove-edged entrance 18" to 66".

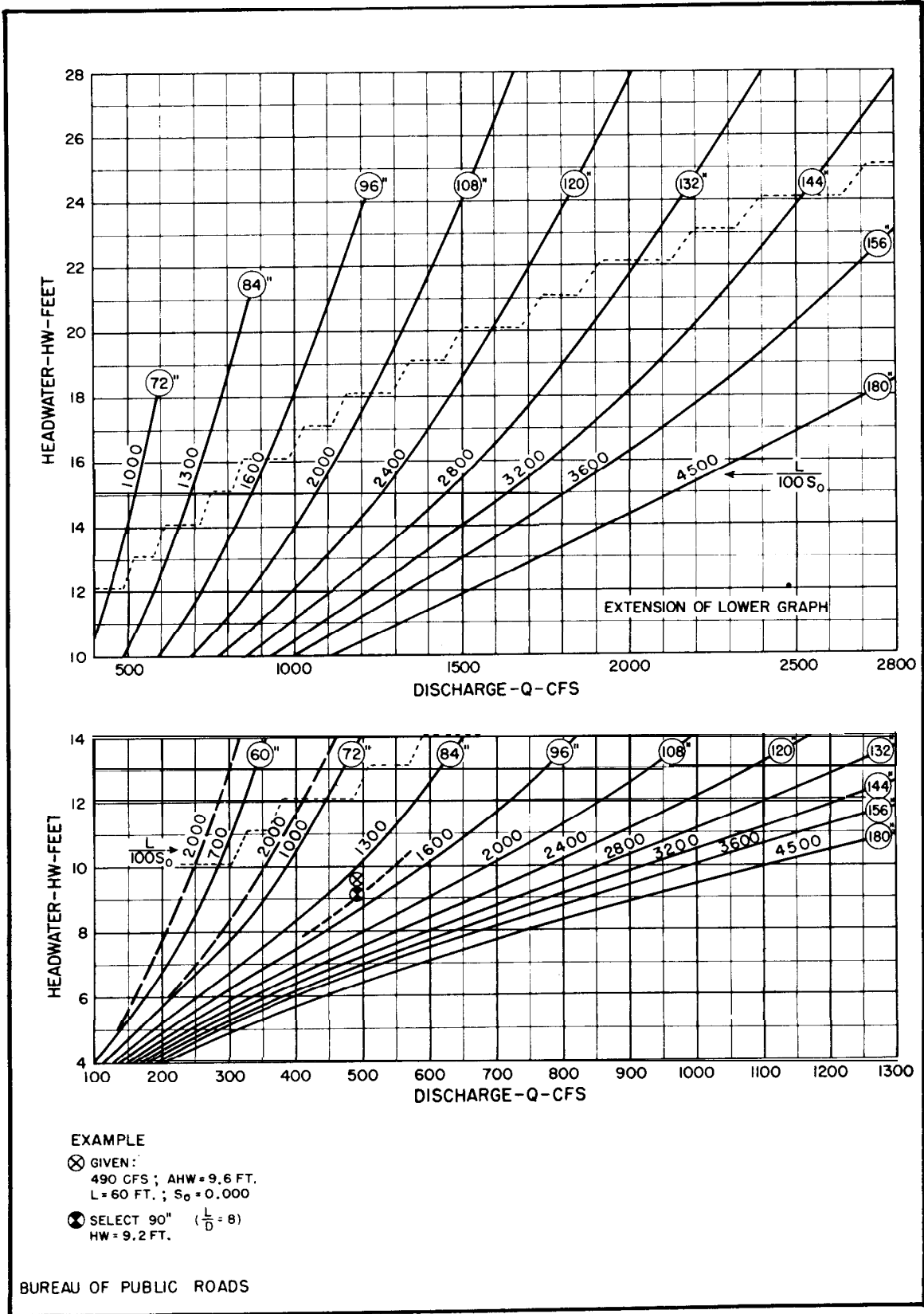

Figure B-27. Culvert capacity circular concrete pipe groove-edged entrance 60" to 180".

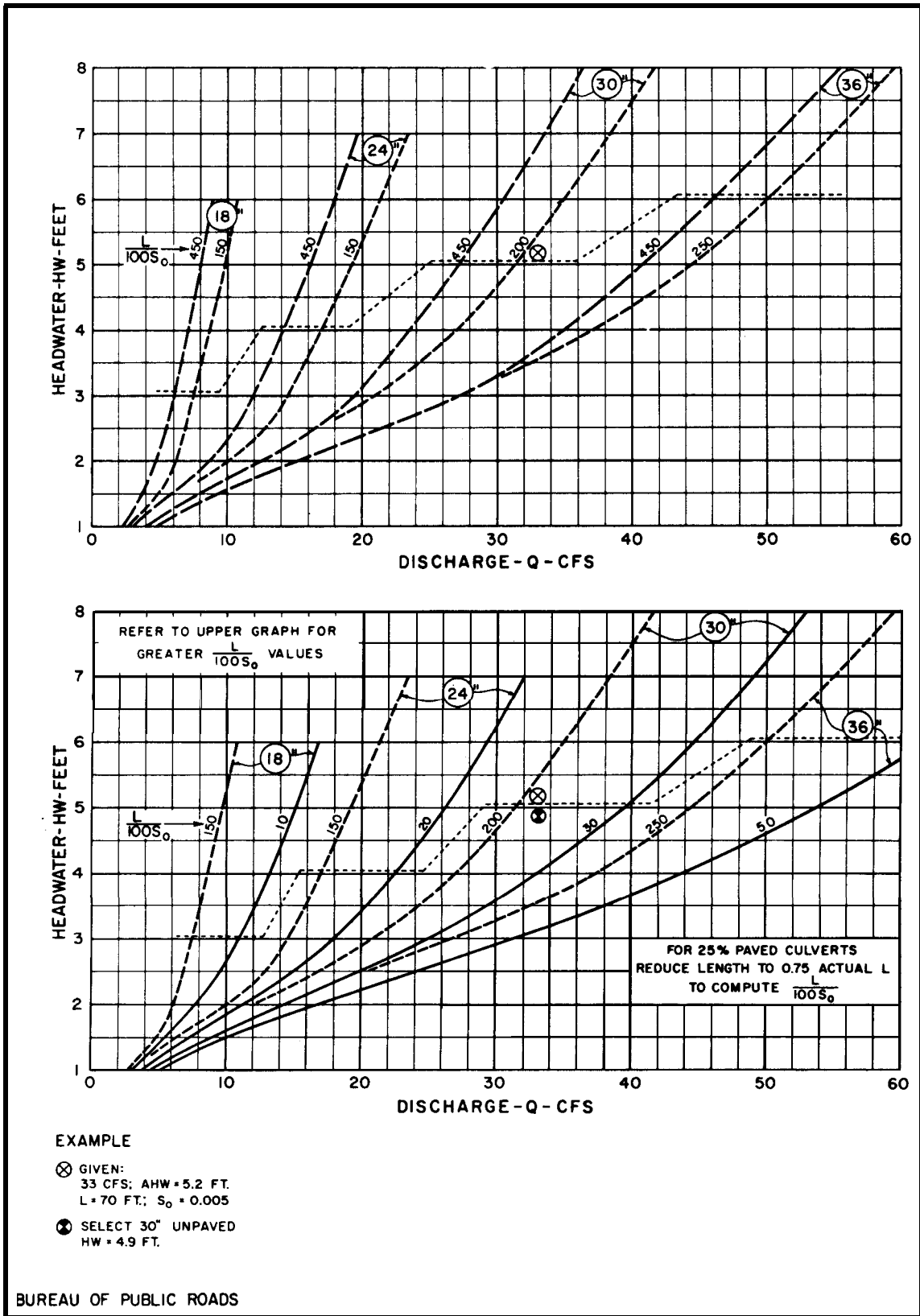

Figure B-28. Culvert capacity standard circular corrugations metal pipe projecting entrance 18" to 36".

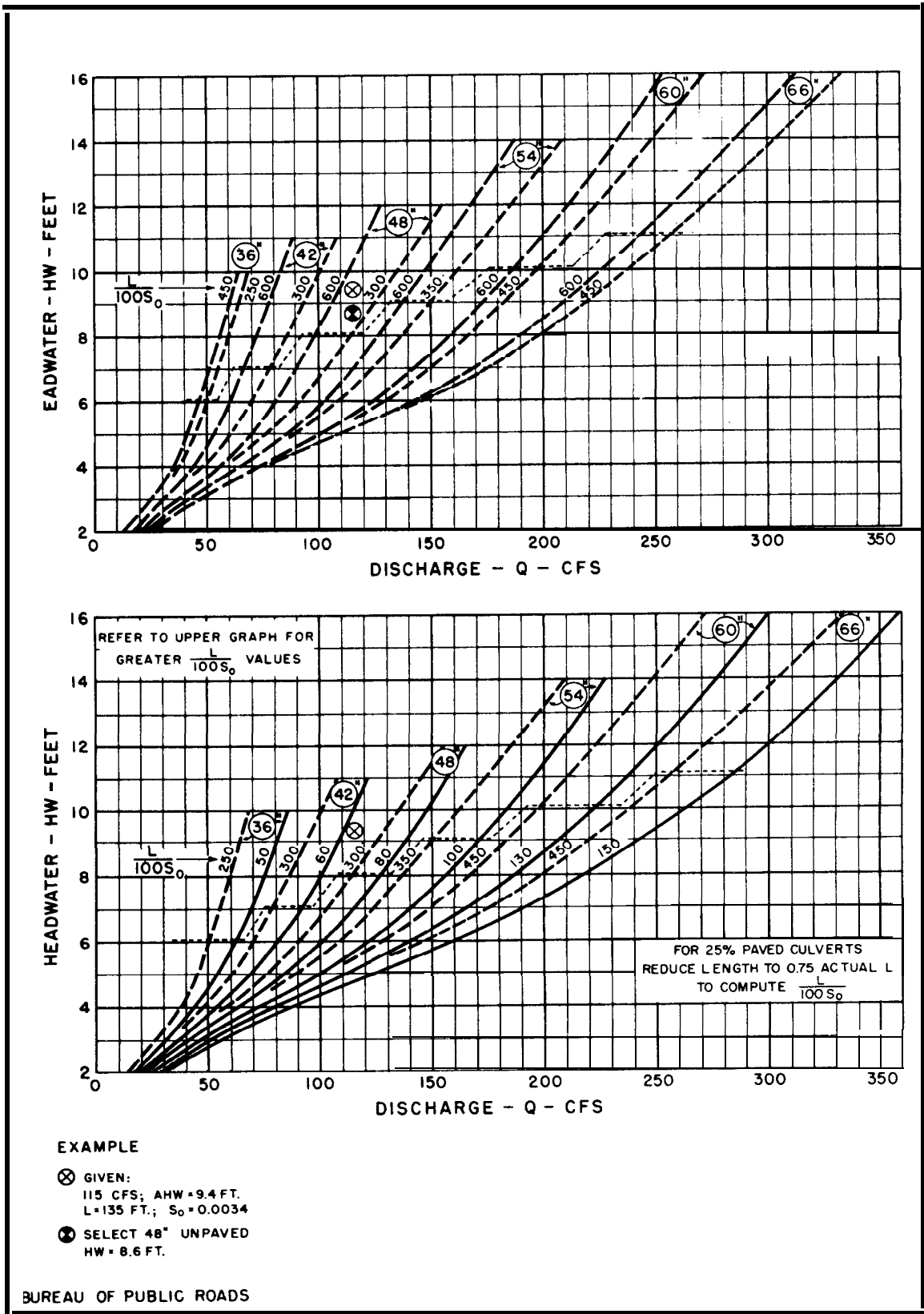
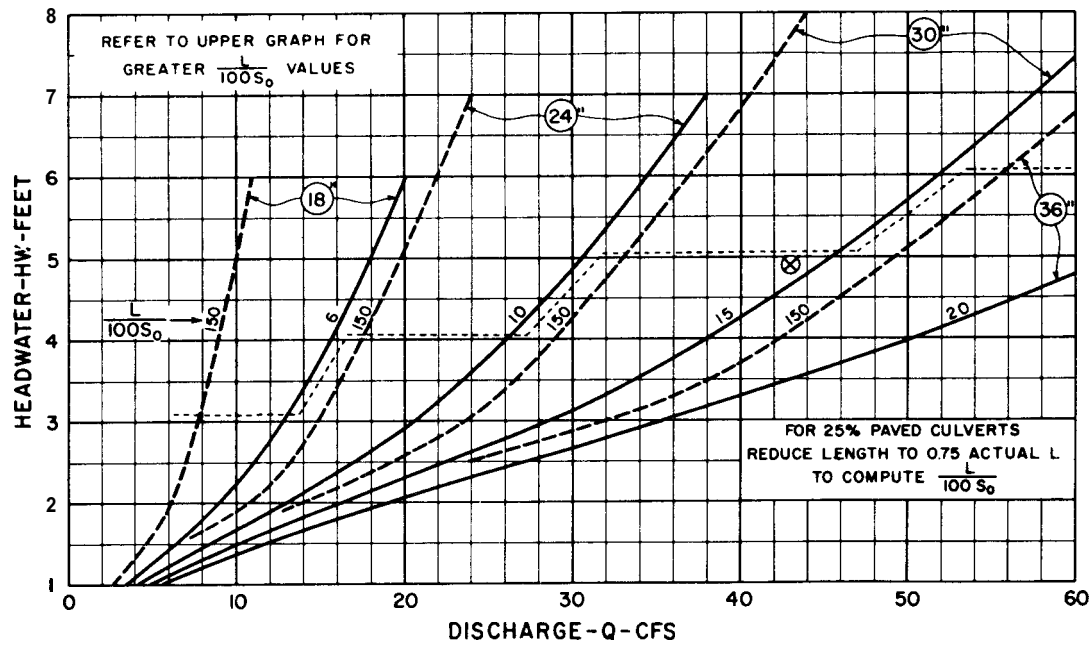
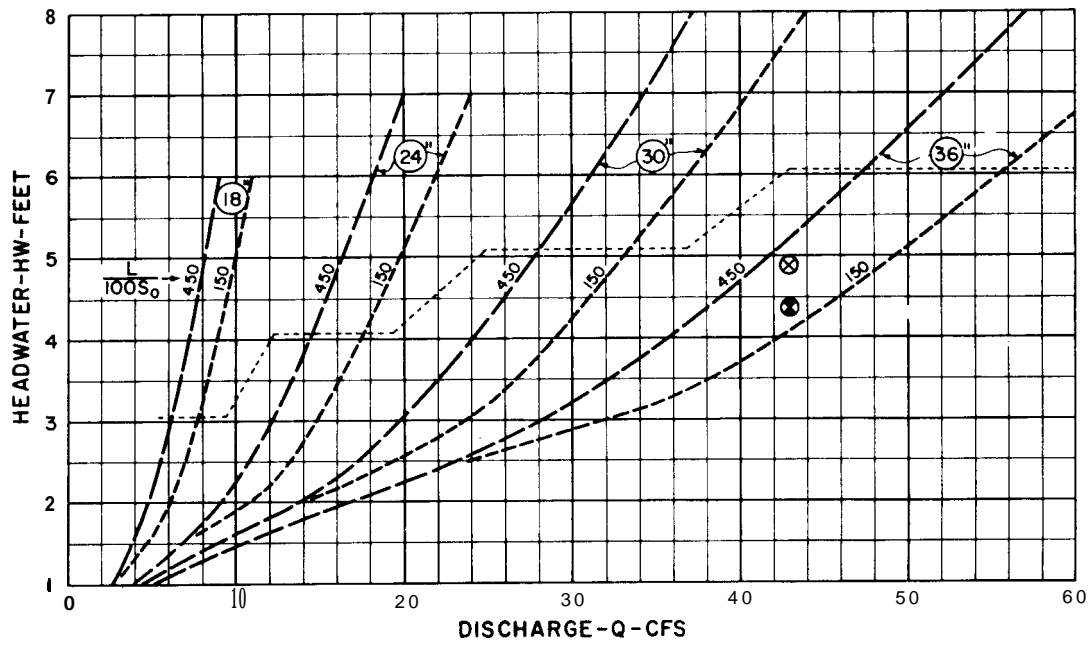

Figure B-29. Culvert capacity standard circular corrugations metal projecting entrance 36" to 66".



EXAMPLE

- ⊗ GIVEN:
43 CFS; AHW = 4.9 FT.
L = 72 FT.; $S_0 = 0.003$
- ⊗ SELECT 36" UNPAVED
HW = 4.4 FT.

BUREAU OF PUBLIC ROADS

Figure B-30. Culvert capacity standard circular corrugations metal headwall entrance 18" to 36".

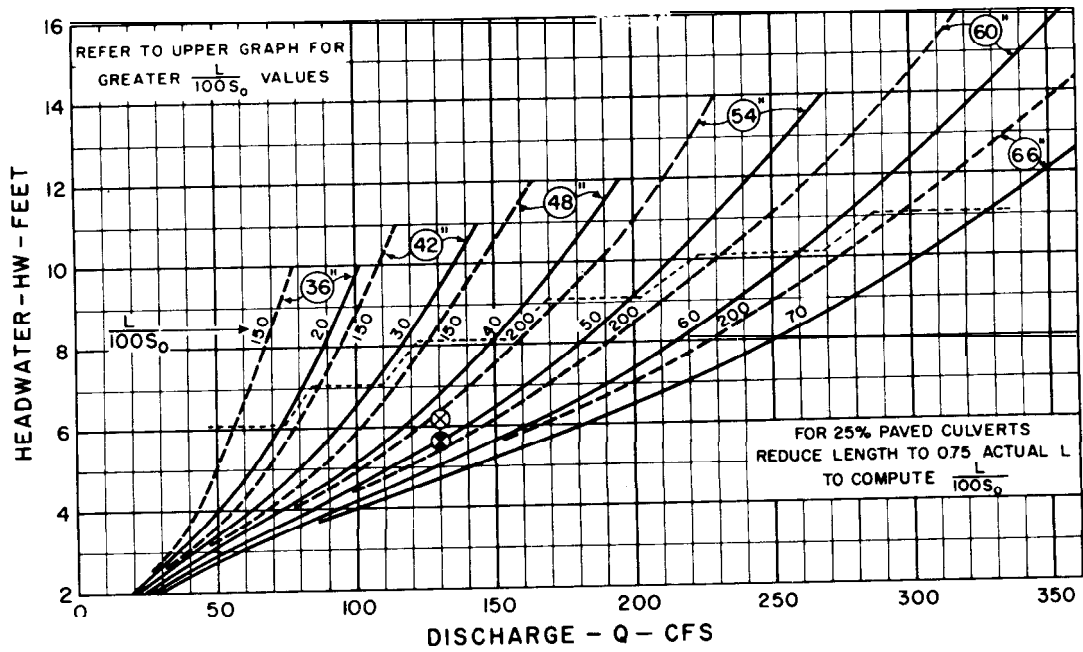
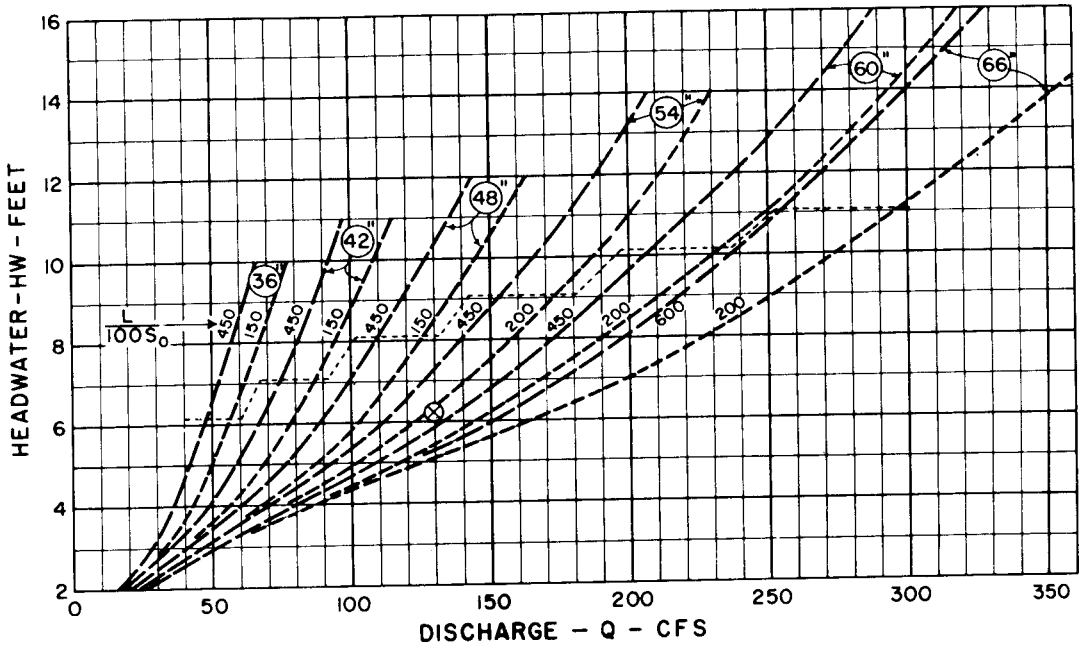

EXAMPLE

- ⊗ GIVEN:
130 CFS; AHW = 6.2 FT.
L = 120 FT.; $S_0 = 0.025$
- ⊙ SELECT 54" UNPAVED
HW = 5.6 FT.

BUREAU OF PUBLIC ROADS

Figure B-31. Culvert capacity standard circular corrugations metal headwall entrance 36" to 66".

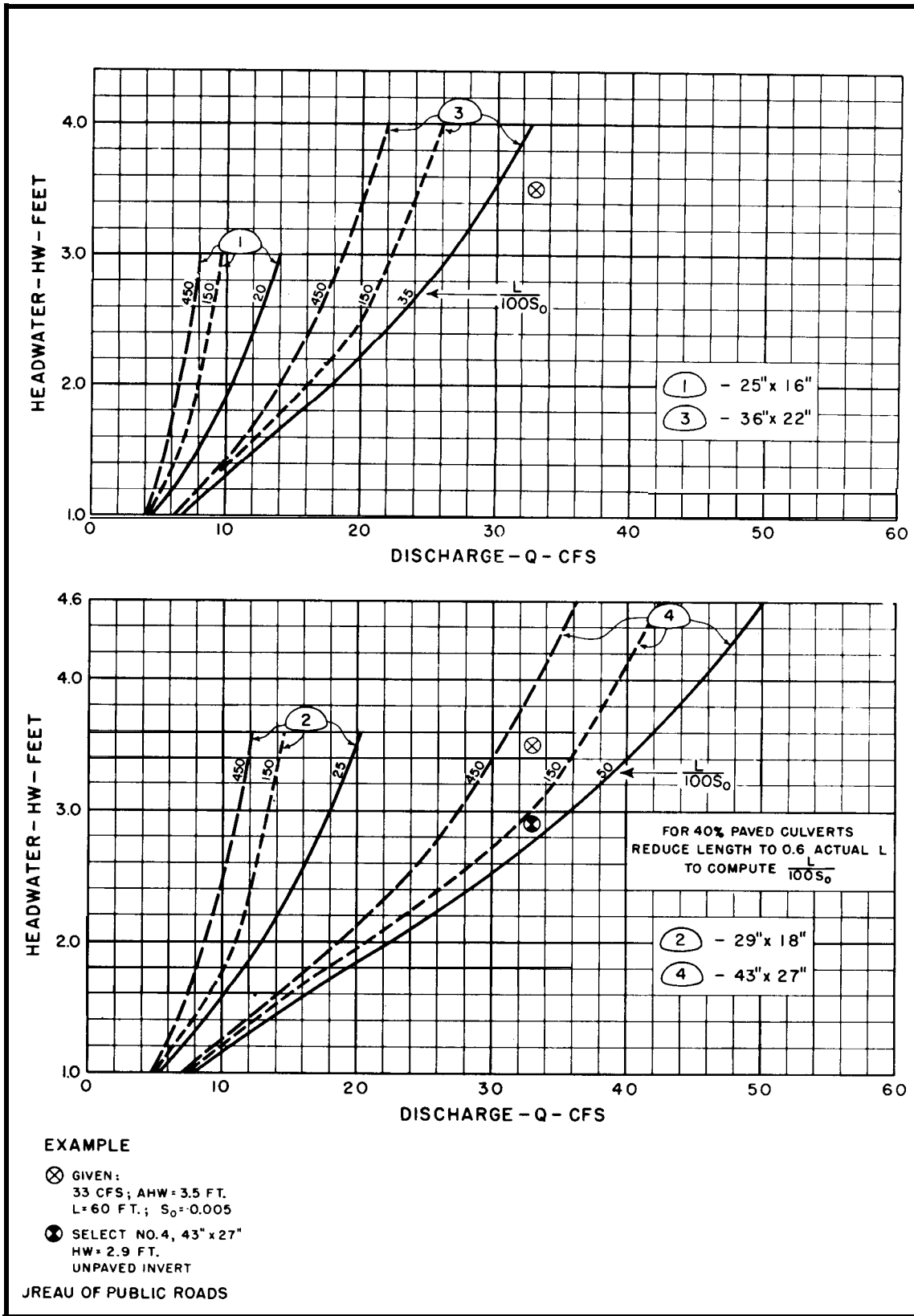

EXAMPLE

⊗ GIVEN:
 33 CFS; AHW = 3.5 FT.
 L = 60 FT.; $S_0 = 0.005$

⊙ SELECT NO. 4, 43" x 27"
 HW = 2.9 FT.
 UNPAVED INVERT

BUREAU OF PUBLIC ROADS

Figure B-32. Culvert capacity standard corrugations metal pipe-arch projecting entrance 25" x 16" to 43" x 27".

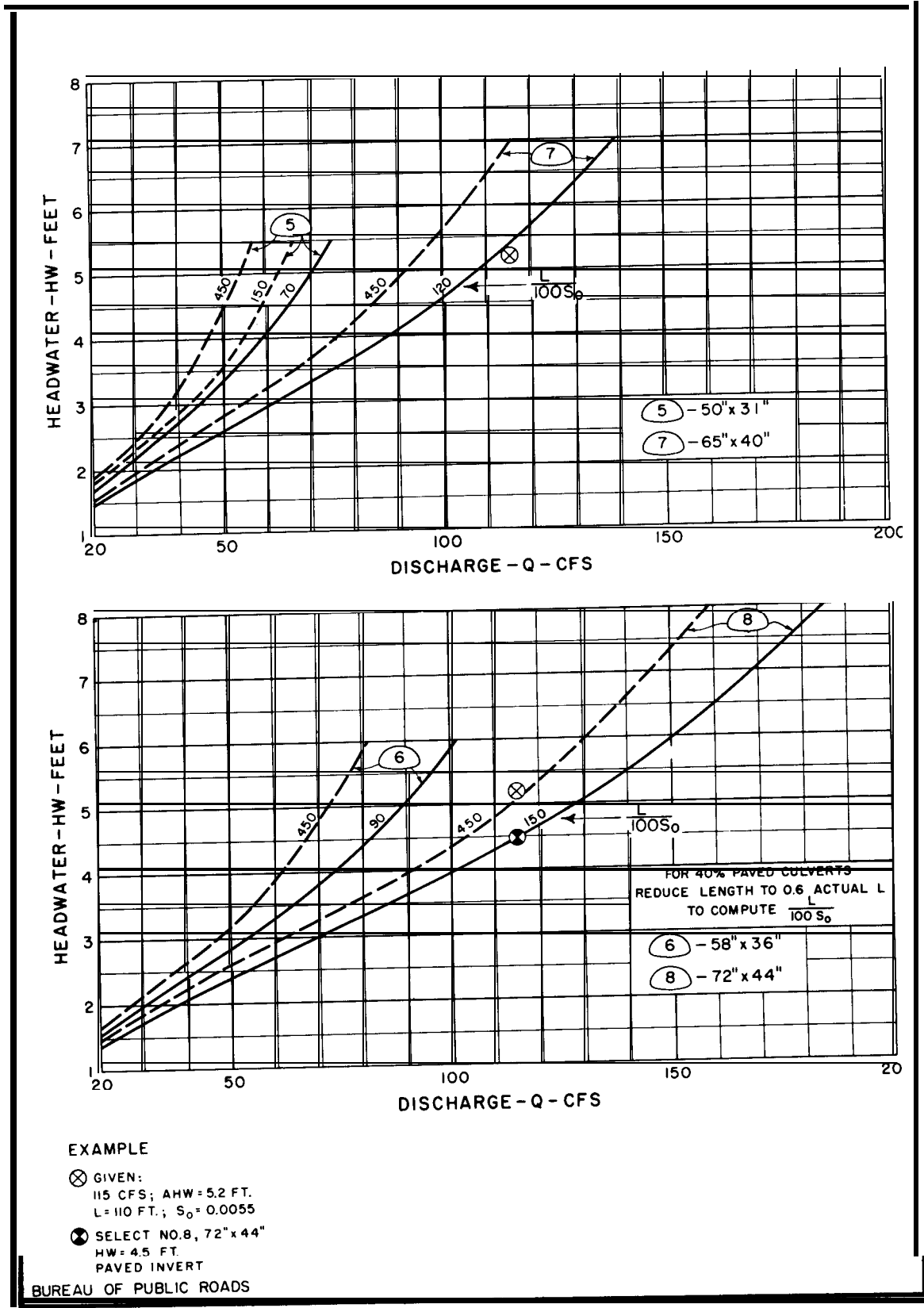

Figure B-33. Culvert capacity standard corrugations metal pipe-arch projecting entrance 50" x 31" to 72" x 44".

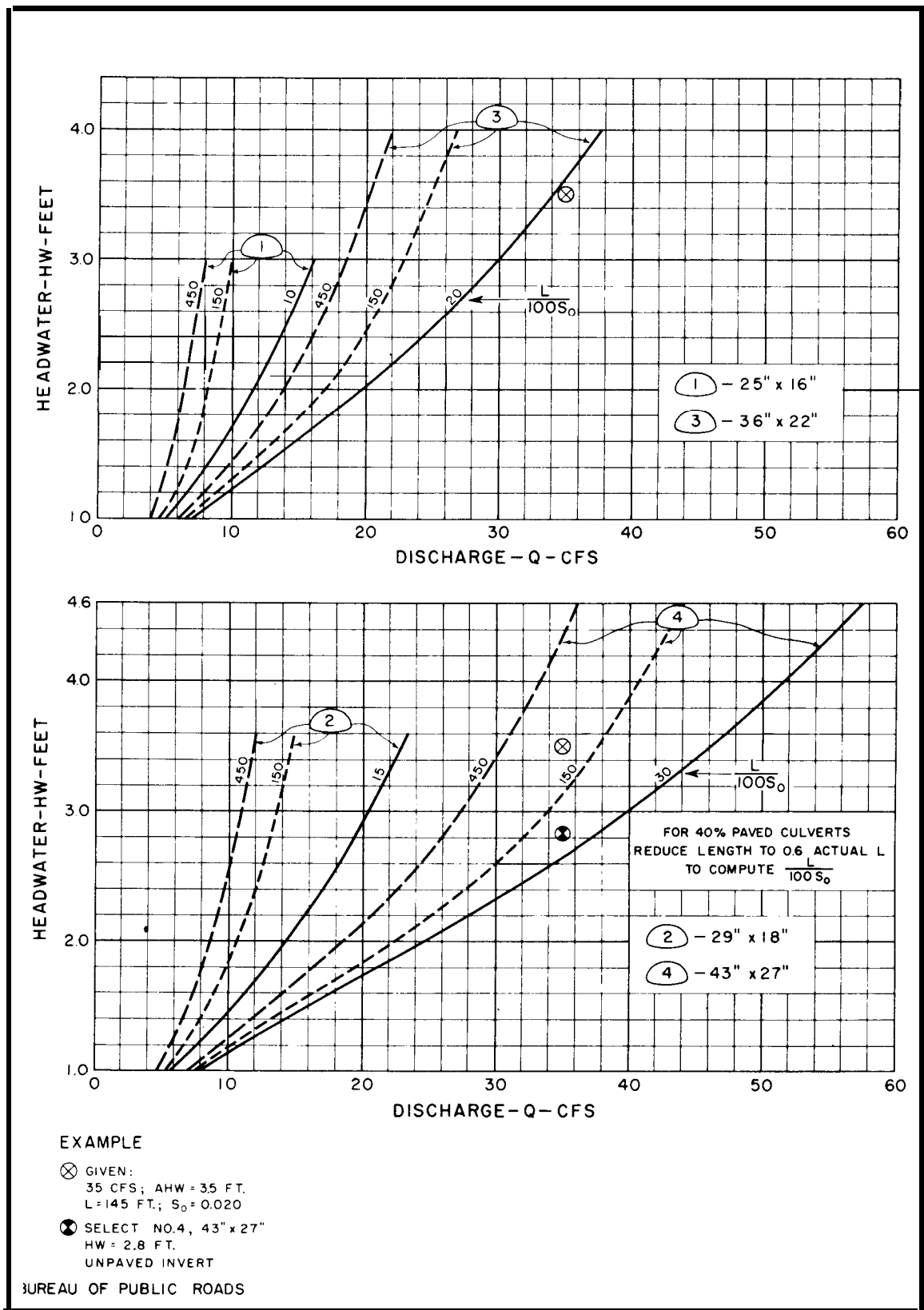

Figure B-34. Culvert capacity standard corrugations metal pipe-arch headwall entrance 25" x 16" to 43" x 27".

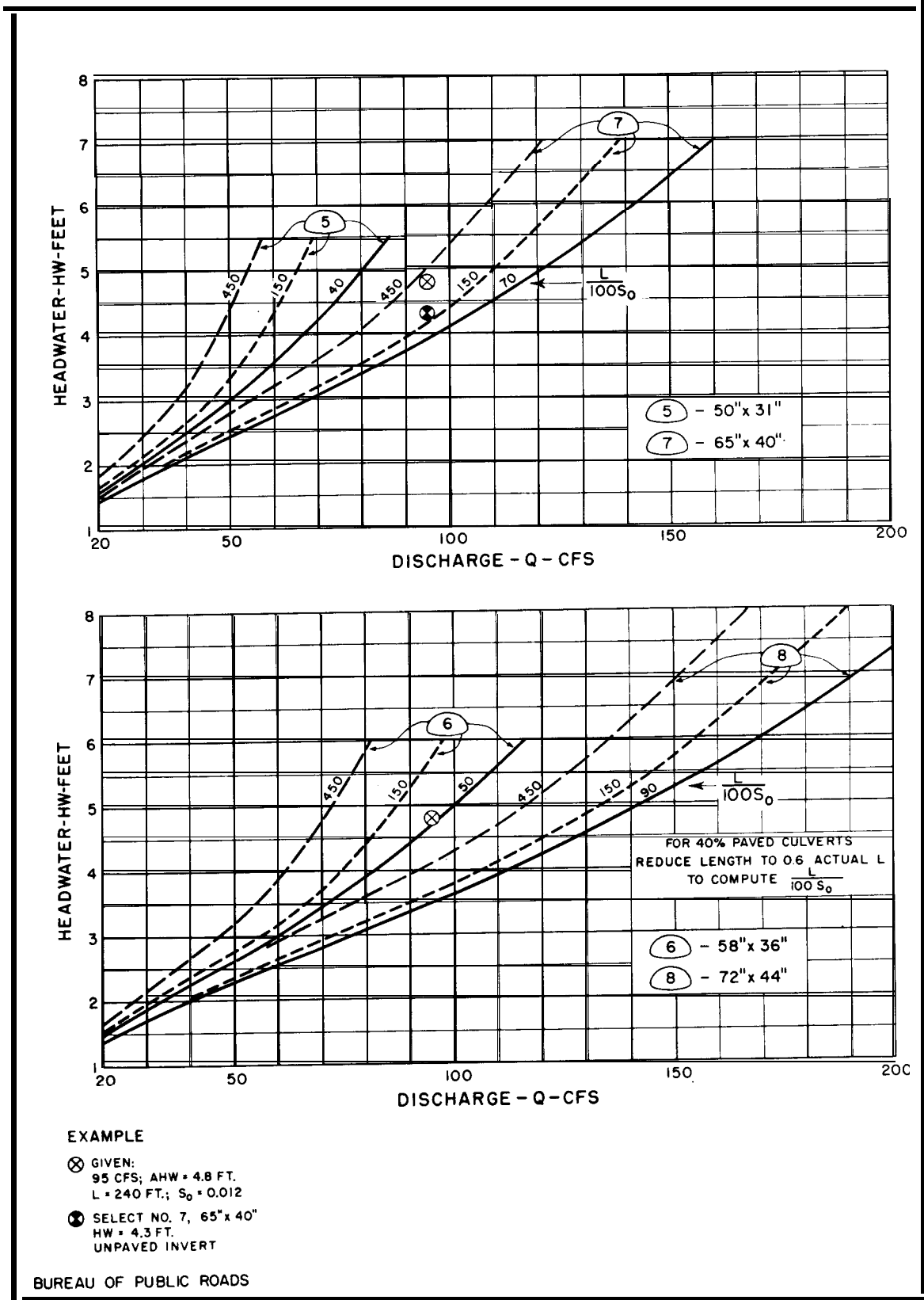

Figure B-35. Culvert capacity standard corrugations metal pipe-arch headwall entrance 50" x 31" to 72" x 44".

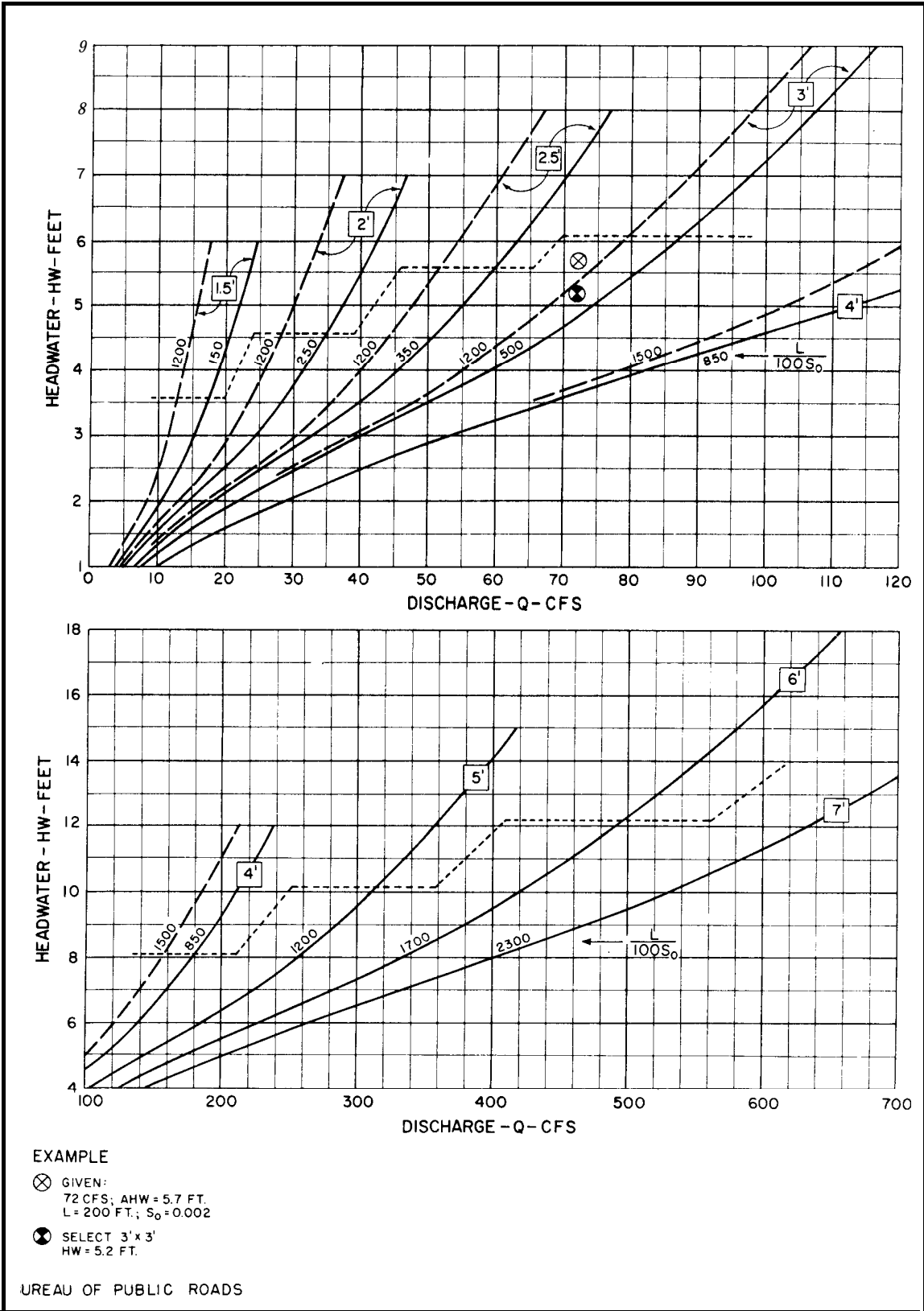

Figure B-36. Culvert capacity square concrete box 90° and 15° wingwall flare 1.5' x 1.5' to 7' x 7'.

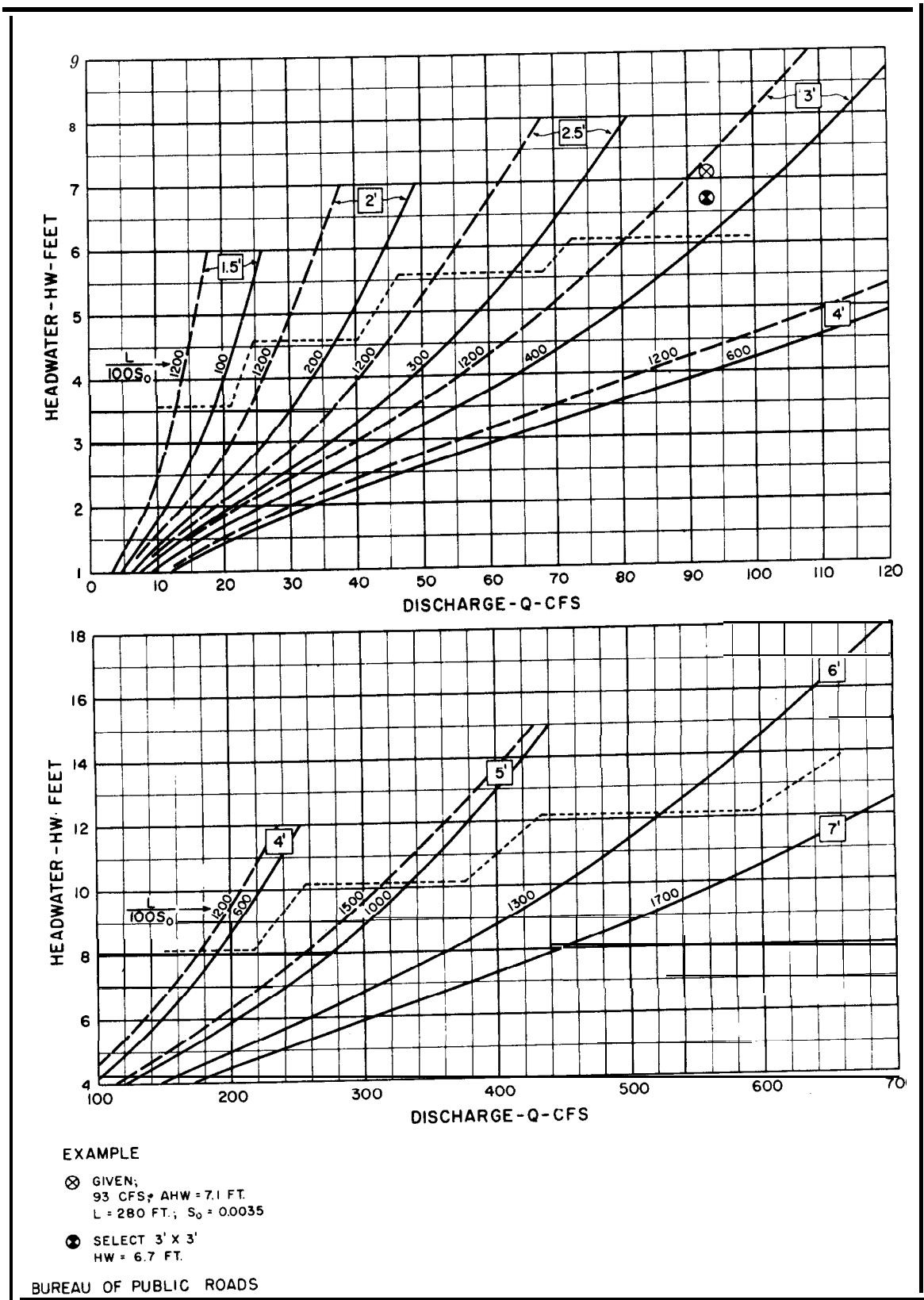

Figure B-37. Culvert capacity square concrete box 30° to 75° wingwall flare 1.5' x 1.5' to 7' x 7'.

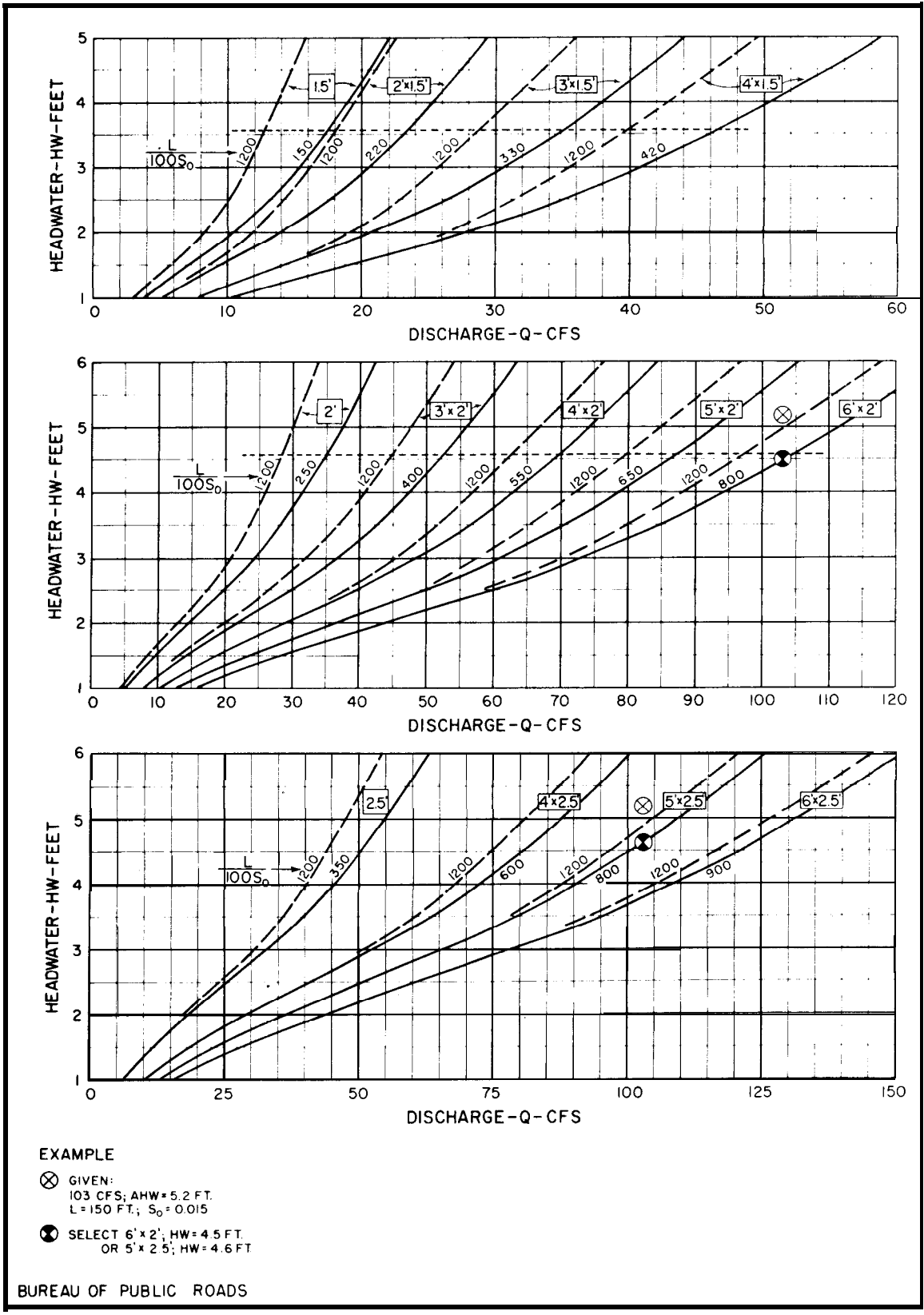

Figure B-38. Culvert capacity rectangular concrete box 90° and 15° wingwall flare 1.5', 2.0' and 2.5' heights.

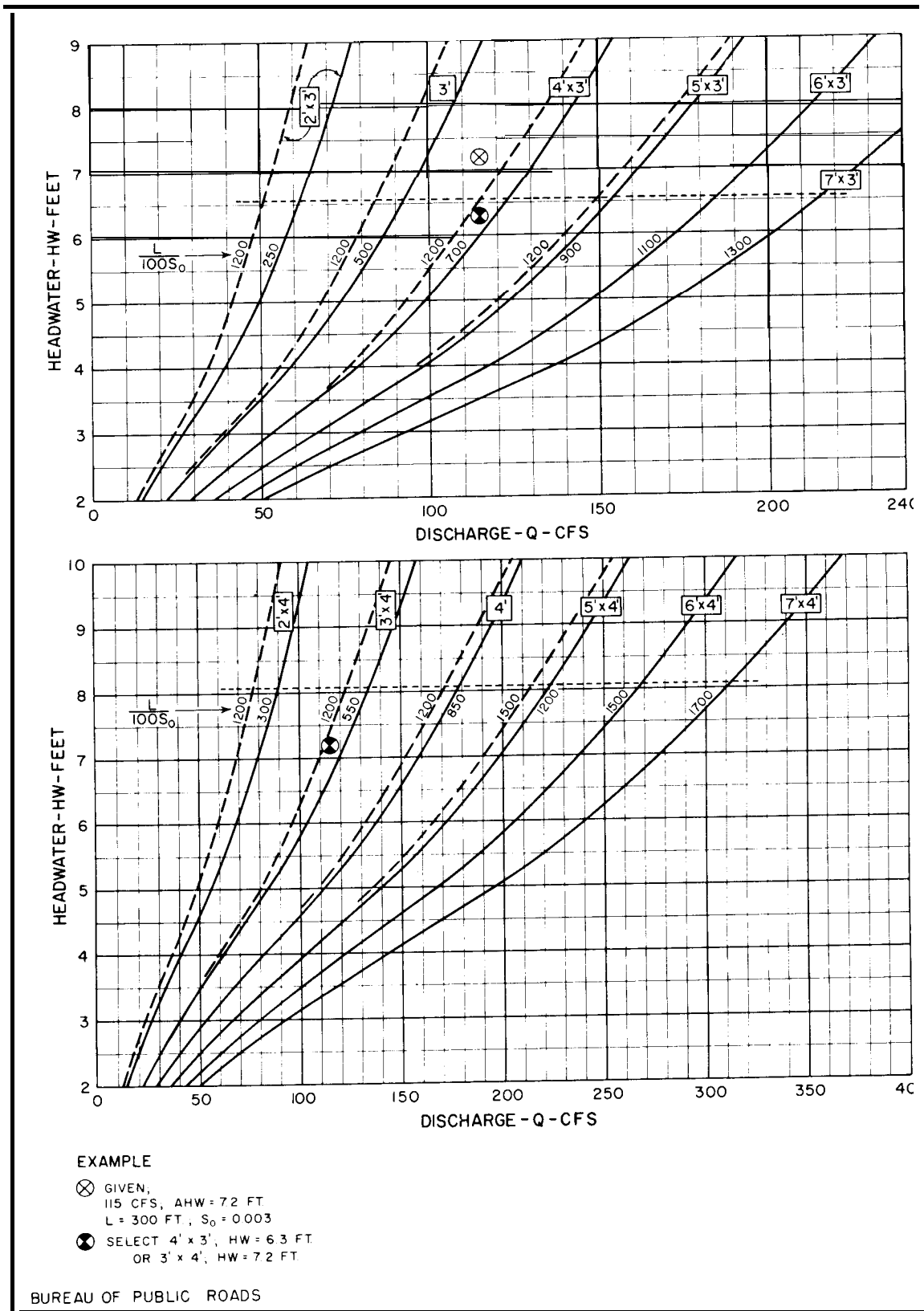

Figure B-39. Culvert capacity rectangular concrete box 90° and 15° wingwall flare 3' and 4' heights.

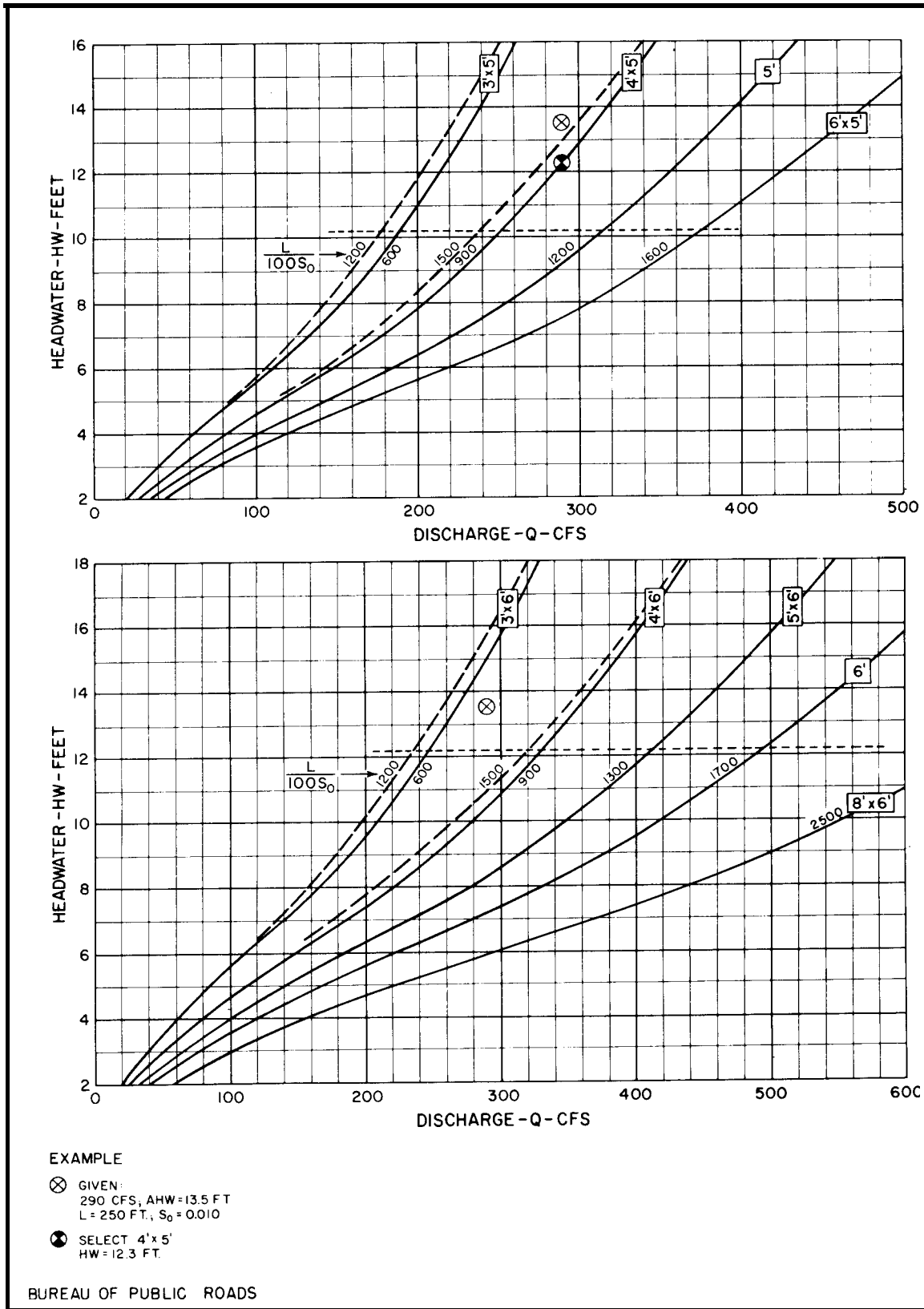

Figure B-40. Culvert capacity rectangular concrete box 90° and 15° wingwall flare 5' and 6' heights.

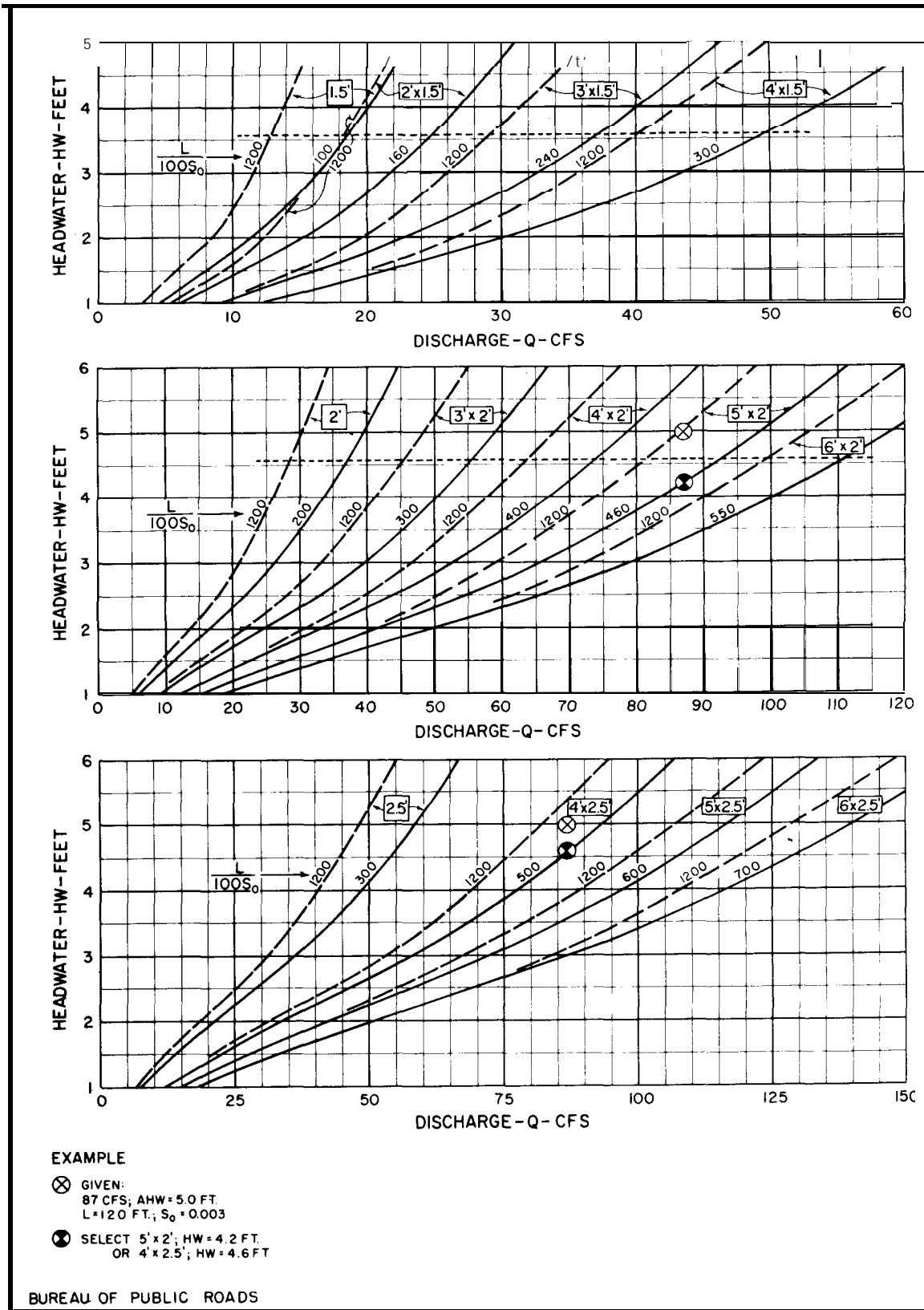

Figure B-41. Culvert capacity rectangular concrete box 30° to 75° wingwall flare 1.5', 2.0' and 2.5' heights.

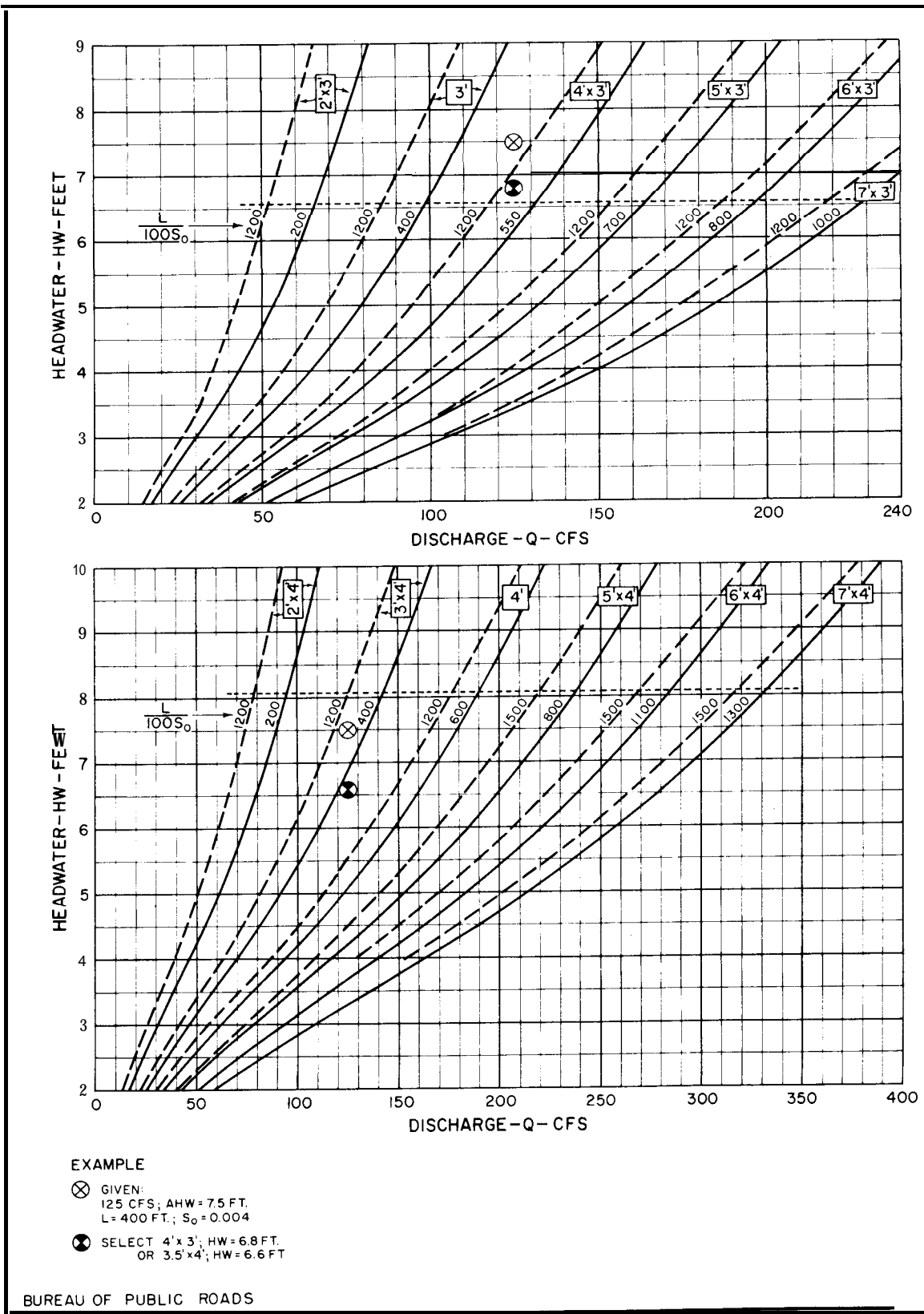

Figure B-42. Culvert capacity rectangular concrete box 30° to 75° wingwall flare 3' and 4' heights.

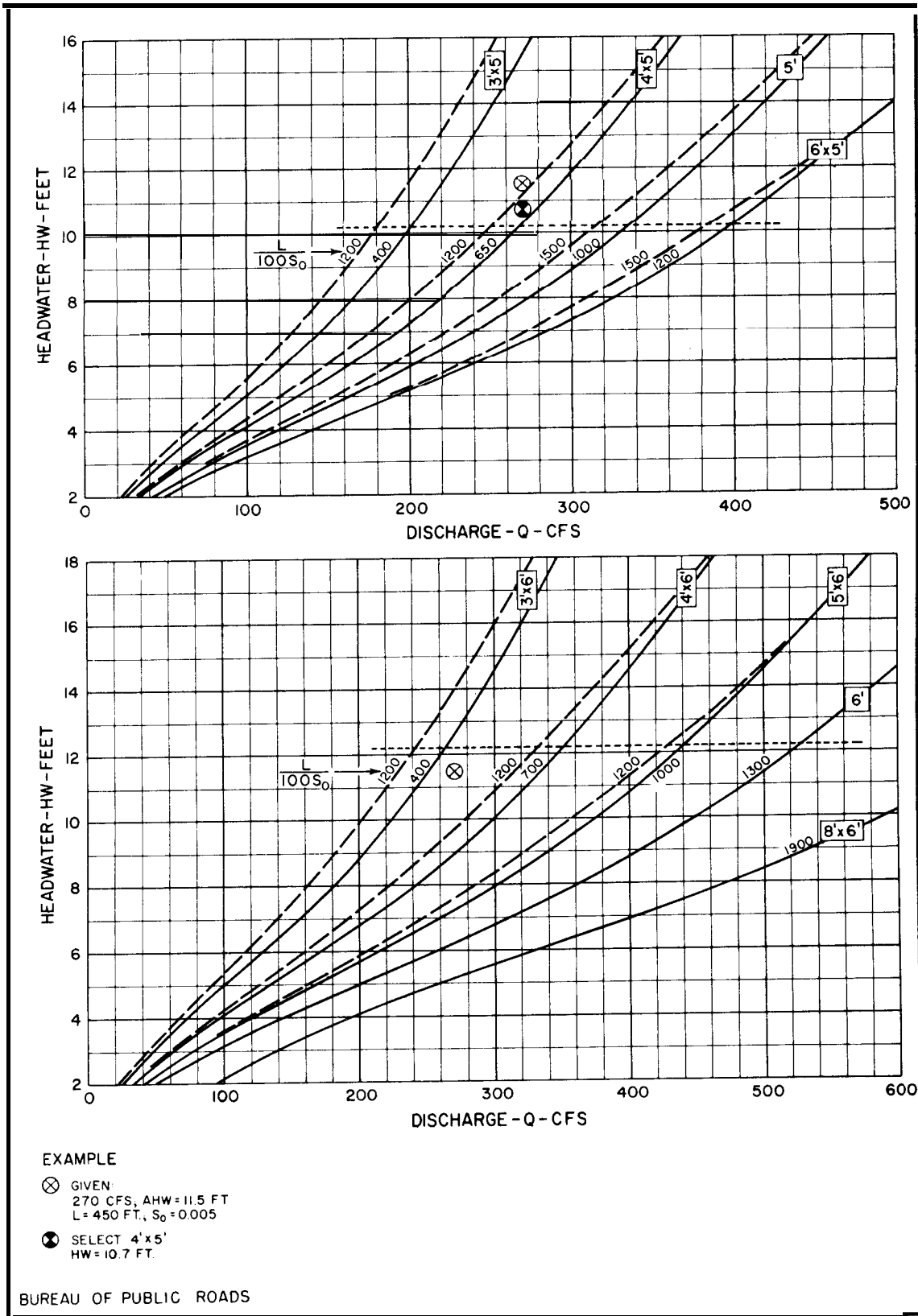

Figure B-43. Culvert capacity rectangular concrete box 30° to 75° wingwall flare 5' and 6' heights.

APPENDIX C

PIPE STRENGTH, COVER, AND BEDDING

C-1. General. A drainage pipe is defined as a structure (other than a bridge) to convey water through a trench or under a fill or some other obstruction. Materials for permanent-type installations include non-reinforced concrete, reinforced concrete, corrugated steel, asbestos-cement, clay, corrugated aluminum alloy, and structural plate steel pipe.

C-2. Selection of type of pipe.

a. The selection of a suitable construction conduit will be governed by the availability and suitability of pipe materials for local conditions with due consideration of economic factors. It is desirable to permit alternates so that bids can be received with contractor's options for the different types of pipe suitable for a specific installation. Allowing alternates serves as a means of securing bidding competition. When alternate designs are advantageous, each system will be economically designed, taking advantage of full capacity, best slope, least depth, and proper strength and installation provisions for each material involved. Where field conditions dictate the use of one pipe material in preference to others, the reasons will be clearly presented in the design analysis.

b. Several factors should be considered in selecting the type of pipe to be used in construction. The factors include strength under either maximum or minimum cover being provided, pipe bedding and backfill conditions, anticipated loadings, length of pipe sections, ease of installation, resistance to corrosive action by liquids carried or surrounding soil materials, suitability of jointing methods, provisions for expected deflection without adverse effect on the pipe structure or on the joints or overlying materials, and cost of maintenance. Although it is possible to obtain an acceptable pipe installation to meet design requirements by establishing special provisions for several possible materials, ordinarily only one or two alternates will economically meet the individual requirements for a proposed drainage system.

C-3. Selection of n values. A designer is continually confronted with what coefficient of

roughness n to use in a given situation. The question of whether n should be based on the new and ideal condition of a pipe or on anticipated condition at a later date is difficult to answer. Sedimentation or paved pipe can affect the coefficient of roughness. Table B-3 gives the n values for smooth interior pipe of any size, shape or type and for annular and helical corrugated metal pipe both unpaved and 25 percent paved. When n values other than those listed are selected, such values will be amply justified in the design analysis.

C-4. Restricted use of bituminous-coated pipe. Corrugated-metal pipe with any percentage of bituminous coating will not be installed where solvents can be expected to enter the pipe. Polymeric coated corrugated steel pipe is recommended where solvents might be expected.

C-5. Minimum cover.

a. In the design and construction of the drainage system it will be necessary to consider both minimum and maximum earth cover allowable on the underground conduits to be placed under both flexible and rigid pavements. Underground conduits are subject to two principal types of loads: dead loads (DL) caused by embankment or trench backfill plus superimposed stationary surface loads, uniform or concentrated; and live or moving loads (LL), including impact. Live loads assume increasing importance with decreasing fill height.

b. AASHTO Standard Specifications for Highway Bridges should be used for all H-20 Highway Loading Analyses. AREA Manual for Railway Engineering should be used for all Cooper's E 80 Railway Loadings. Appropriate pipe manufacturer design manuals should be used for maximum cover analyses.

c. Drainage systems should be designed in order to provide an ultimate capacity sufficient to serve the planned installation. Addition to, or replacement of, drainage lines following initial construction is costly.

d. Investigations of in-place drainage and erosion control facilities at 50 military installations

were made during the period 1966 to 1972. The facilities observed varied from one to more than 30 years of age. The study revealed that buried conduits and associated storm drainage facilities installed from the early 1940's until the mid-1960's appeared to be in good to excellent structural condition. However, many reported failures of buried conduits occurred during construction. Therefore, it should be noted that minimum conduit cover requirements are not always adequate during construction. When construction equipment, which may be heavier than live loads for which the conduit has been designed, is operated over or near an already in place underground conduit, it is the responsibility of the contractor to provide any additional cover during construction to avoid damage to the conduit. Major improvements in the design and construction of buried conduits in the two decades mentioned include, among other items, increased strength of buried pipes and conduits,

increased compaction requirements, and revised minimum cover tables.

e. The necessary minimum cover in certain instances may determine pipe grades. A safe minimum cover design requires consideration of a number of factors including selection of conduit material, construction conditions and specifications, selection of pavement design, selection of backfill material and compaction, and the method of bedding underground conduits. Emphasis on these factors must be carried from the design stage through the development of final plans and specifications.

f. Tables C-1 through C-6 identify certain suggested cover requirements for storm drains and culverts which should be considered as guidelines only. Cover requirements have been formulated for asbestos-cement pipe, reinforced and non-reinforced concrete pipe, corrugated-aluminum-alloy

Table C-1. Suggested Maximum Cover Requirements for Asbestos-Cement Pipe
H-20 Highway Loading

| Diameter in. | Suggested Maximum Cover Above Top of Pipe, ft | | | | |
|-----------------|---|------|------|------|------|
| | Circular Section | | | | |
| | Class | | | | |
| | 1500 | 2000 | 2500 | 9000 | 3750 |
| 12 | 9 | 13 | 16 | 19 | 24 |
| 15 | 10 | 13 | 17 | 19 | 24 |
| 18 | 10 | 13 | 17 | 20 | 25 |
| 21 | 10 | 13 | 17 | 20 | 25 |
| 24 | 10 | 14 | 17 | 20 | 25 |
| 27 | 10 | 14 | 17 | 20 | 25 |
| 30 | 11 | 14 | 17 | 21 | 24 |
| 33 | 11 | 14 | 17 | 21 | 26 |
| 36 | 11 | 14 | 17 | 21 | 26 |
| 42 | 11 | 14 | 17 | 21 | 26 |

U.S. Army Corps of Engineers

Notes:

1. The suggested values shown are for average conditions and are to be considered as guidelines only for dead load plus H-20 live load.
2. Soil conditions, trench width and bedding conditions vary widely throughout varying climatic and geographical areas.
3. Calculations to determine maximum cover should be made for all individual pipe and culvert installations underlying roads, streets and open storage areas subject to H-20 live loads. Cooper E-80 ; railway loadings should be independently made.
4. Cover depths are measured from the bottom of the subbase of pavements, or the top of unsurfaced areas, to top of pipe.
5. Calculations to determine maximum cover for Cooper E-80 railway loadings are measured from the bottom of the tie to the top of the pipe.
6. The number in the class designation for asbestos-cement pipe is the minimum 3-edge test load to produce failure in pounds per linear foot. It is independent of pipe diameter. An equivalent to the D-load can be obtained by dividing the number in the class designation by the internal pipe diameter in feet.
7. If pipe produced by a manufacturer exceeds the strength requirements established by indicated standards then cover depths may be adjusted accordingly.
8. See table C-9 for suggested minimum cover requirements.

Table C-2. Suggested Maximum Cover Requirements for Concrete Pipe

Reinforced Concrete
H-20 Highway Loading

| Diameter in. | Suggested Maximum Cover Above Top of Pipe, ft., | | | | |
|-----------------|---|--------|--------|--------|--------|
| | Circular Section | | | | |
| | Class | | | | |
| | 1200-D | 1500-D | 2000-D | 3000-D | 3750-D |
| 12 | | 8 | 15 | | |
| 24 | | 10 | 16 | 46 | |
| 36 | | 10 | 16 | 34 | |
| 48 | | 10 | 16 | 29 | 47 |
| 60 | 9 | 10 | 16 | 27 | 40 |
| 72 | 9 | 11 | 16 | 26 | 37 |
| 84 | 9 | 11 | 15 | 25 | |
| 108 | 10 | 12 | 15 | | |

Non-Reinforced Concrete

| Diameter in. | Suggested Maximum Cover Above Top of Pipe, ft. | | |
|-----------------|--|----|-----|
| | Circular Section | | |
| | I | II | III |
| 12 | 14 | 14 | 17 |
| 24 | 13 | 13 | 14 |
| 36 | 9 | 12 | 12 |

U.S. Army Corps of Engineers

Notes:

1. The suggested values shown are for average conditions and are to be considered as guidelines only for dead load plus H-20 live load.
2. Soil conditions, trench width and bedding conditions vary widely throughout varying climatic and geographical areas.
3. Calculations to determine maximum cover should be made for all individual pipe and culvert installations underlying roads, streets and open storage areas subject to H-20 live loads. Cooper E-80 railway loadings should be independently made.
4. Cover depths are measured from the bottom of the subbase of pavements, or the top of unsurfaced areas, to top of pipe.
5. Calculations to determine maximum cover for Cooper E-80 railway loadings are measured from the bottom of the tie to the top of the pipe.
6. "D" loads listed for the various classes of reinforced-concrete pipe are the minimum required 3-edge test loads to produce ultimate failure in pounds per linear foot of interval pipe diameter.
7. Each diameter pipe in each class designation of non-reinforced concrete has a different D-load value which increases with wall thickness.
8. If pipe produced by a manufacturer exceeds the strength requirements established by indicated standards, then cover depths may be adjusted accordingly.
9. See table C-9 for suggested minimum cover requirements.

Change 1 C-3

pipe, corrugated-steel pipe, structural-plate-aluminum-alloy pipe, and structural-plate-steel pipe. The different sizes and materials of conduit and pipe have been selected to allow the reader an appreciation for the many and varied items which are commercially available for construction purposes. The cover depths listed are suggested only for average bedding and backfill conditions. Deviations from average conditions may result in significant minimum cover requirements and separate cover analyses must be made in each instance of a deviation from average conditions. Specific bedding, backfill and trench widths may be required in certain loca-

tions; each condition deviating from the average condition should be analyzed separately. Where warranted by design analysis the suggested maximum cover may be exceeded.

- C-6. Classes of bedding and installation. Figures C-1 through C-5 indicate the classes of bedding for conduits. Figure C-6 is a schematic representation of the subdivision of classes of conduit installation which influences loads on underground conduits.

Change 1 C-3

Change 1 C-3

Table C-3. Suggested Maximum Cover Requirements for Corrugated-Aluminum-Alloy Pipe, Riveted, Helical, or Welded Fabrication 2 2/3 Inch Spacing, 1/2 -Inch Deep Corrugations H-20 Highway Loading

| Diameter in. | Suggested Maximum Cover Above Top of Pipe, ft | | | | | | | | | |
|-----------------|---|------|------|------|------|------------------------------|------|------|------|------|
| | Circular Section | | | | | Vertically Elongated Section | | | | |
| | Thickness, in. | | | | | Thickness, in. | | | | |
| | .060 | .075 | .105 | .135 | .164 | .060 | .075 | .105 | .135 | .164 |
| 12 | 50 | 50 | 86 | 90 | 93 | | | | | |
| 15 | 40 | 40 | 69 | 72 | 74 | | | | | |
| 18 | 33 | 33 | 57 | 60 | 62 | | | | | |
| 24 | 25 | 25 | 43 | 45 | 46 | | | | | |
| 30 | 20 | 20 | 34 | 36 | 37 | | | | | |
| 36 | 16 | 16 | 28 | 30 | 31 | | | | | |
| 42 | 16 | 16 | 28 | 30 | 31 | | | 50 | 52 | 53 |
| 48 | | | 28 | 30 | 31 | | | 43 | 45 | 47 |
| 54 | | | 28 | 30 | 31 | | | | | |
| 60 | | | | 30 | 31 | | | | | |
| 66 | | | | | 31 | | | | | |
| 72 | | | | | 31 | | | | | |

U.S. Army Corps of Engineers

Notes:

1. Corrugated-aluminum-alloy pipe will conform to the requirements of Federal Specification W W-P-402.
2. The suggested values shown are for average conditions and are to be considered as guidelines only for dead load plus H-20 live load Cooper E-80 railway loadings should be independently made.
3. Soil conditions, trench width and bedding conditions vary widely throughout varying climatic and geographical areas.
4. Calculations to determine maximum cover should be made for all individual pipe and culvert installations underlying roads, streets and open storage areas subject to H-20 live loads.
5. Cover depths are measured from the bottom of the subbase of pavements, or the top of unsurfaced areas, to top of pipe.
6. Calculations to determine maximum cover for Cooper E-80 railway loadings are measured from the bottom of the tie to the top of the pipe.
7. Vertical elongation will be accomplished by shop fabrication and will generally be 5 % of the pipe diameter.
8. See table C-9 for suggested minimum cover requirements.

C-4 Change 1

• C-7. Strength of pipe. Pipe shall be considered of ample strength when it meets the conditions specified for the loads indicated in tables C-1 through C-8. When railway or vehicular wheel loads or loads due to heavy construction equipment (live loads, LL) impose heavier loads, or when the earth (or dead loads, DL) vary materially from those normally encountered, these tables cannot be used for pipe installation design and separate analyses must be made. The suggested minimum and maximum cover shown in the tables pertain to pipe installations in which the back fill material is compacted to at least 90 percent of CE55 (MIL-STD-621) or AASHTO-T99 density (100 percent for cohesionless sands and gravels). This does not modify requirements for any greater degree of compaction specified for other reasons. It is emphasized that proper bedding, backfilling, compaction, and prevention of infiltration of backfill material into pipe are important not only to the pipe, but also to protect overlying and nearby structures. When in doubt about minimum and maximum cover for local conditions, a

separate cover analysis must be performed.

C-8 Rigid pipe. Tables C-1 and C-2 indicate maximum and minimum cover for trench conduits employing asbestos-cement pipe and concrete pipe. If positive projecting conduits are employed they are those which are installed in shallow bedding with a part of the conduit projecting above the surface of the natural ground and then covered with an embankment. Due allowance will be made in amounts of minimum and maximum cover for positive projecting conduits. Table C-9 suggests guidelines for minimum cover to protect the pipe during construction and the minimum finished height of cover.

C-9. Flexible pipe. Suggested maximum cover for trench and positive projecting conduits are indicated in tables C-3 through C-6 for corrugated-aluminum-alloy pipe, corrugated-steel pipe, structural-plate-aluminum-alloy pipe, and structural-plate-steel pipe. Conditions other than those stated in the tables, particularly other loading conditions will be compensated for as necessary. For

C-4 Change 1

C-4 Change 1

Table C-4. Suggested Maximum Cover Requirements for Corrugated-Steel-Pipe, 2½ Inch Spacing, ¼-Inch Deep Corrugations

| H-20 HIGHWAY LOADING | | | | | | | | | | | | |
|---------------------------------------|-----------------------------|------|------|------|------|------|-----------------------------|------|------|------|------|------|
| MAXIMUM COVER ABOVE TOP OF PIPE, FEET | | | | | | | | | | | | |
| DIAMETER, INCHES | RIVETED - THICKNESS, INCHES | | | | | | HELICAL - THICKNESS, INCHES | | | | | |
| | .052 | .064 | .079 | .109 | .138 | .168 | .052 | .064 | .079 | .109 | .138 | .168 |
| 12 | 92 | 92 | 101 | 130 | | | 170 | 213 | 266 | 372 | | |
| 15 | 74 | 74 | 80 | 104 | | | 136 | 170 | 212 | 298 | | |
| 18 | 61 | 61 | 67 | 86 | | | 113 | 142 | 173 | 212 | | |
| 21 | 53 | 53 | 57 | 74 | | | 97 | 121 | 139 | 164 | | |
| 24 | 46 | 46 | 50 | 65 | 68 | | 85 | 106 | 120 | 137 | 155 | |
| 27 | 41 | 41 | 44 | 57 | 60 | | 75 | 94 | 109 | 120 | 133 | |
| 30 | 37 | 37 | 40 | 52 | 54 | | 68 | 85 | 101 | 110 | 119 | |
| 36 | 30 | 30 | 33 | 43 | 45 | | 56 | 71 | 88 | 98 | 103 | |
| 42 | 34 | 34 | 47 | 74 | 77 | 81 | 48 | 60 | 76 | 92 | 95 | 99 |
| 48 | | 30 | 41 | 65 | 68 | 71 | | 53 | 66 | 88 | 91 | 93 |
| 54 | | | 36 | 57 | 60 | 63 | | | 59 | 82 | 88 | 90 |
| 60 | | | | 52 | 54 | 57 | | | | 74 | 86 | 87 |
| 66 | | | | | 49 | 51 | | | | | 85 | 86 |
| 72 | | | | | 45 | 47 | | | | | 79 | 85 |
| 78 | | | | | | 43 | | | | | | 84 |
| 84 | | | | | | 40 | | | | | | 75 |

U. S. Army Corps of Engineers

Notes :

1. Corrugated steel pipe will conform to the requirements of Federal Specification WW-P-405.
2. The suggested maximum heights of cover shown in the table are calculated on the basis of the current AASHTO Standard Specifications for Highway Bridges and are based on circular pipe.
3. Soil conditions, trench width and bedding conditions vary widely throughout varying climatic and geographical areas.
4. Calculations to determine maximum cover should be made for all individual pipe and culvert installations underlying roads, streets and open storage areas subject to H-20 live loads. Cooper E-80 railway loadings should be independently made.
5. Cover depths are measured from the bottom of the subbase of pavements, or the top of unsurfaced areas, to top of pipe.
6. Calculations to determine maximum cover for Cooper E-80 railway loadings are measured from the bottom of the tie to the top of the pipe.
7. If pipe produced by a manufacturer exceeds the strength requirements established by indicated standards then cover depths may be adjusted accordingly.
8. See table C-9 for suggested minimum cover requirements.

Table C-5. Suggested Maximum Cover Requirements for Structural-Plate-Aluminum-Alloy Pipe, 9-Inch Spacing, 2 1/2-Inch Corrugations
H-20 Highway Loading

| Diameter, in. | Suggested Maximum Cover Above Top of Pipe, ft | | | | | | |
|------------------|---|-------|------|-------|------|-------|-------|
| | Circular Section | | | | | | |
| | Thickness, in. | | | | | | |
| | 0.10 | 0.125 | 0.15 | 0.175 | 0.20 | 0.225 | 0.250 |
| 72 | 24 | 32 | 41 | 48 | 55 | 61 | 64 |
| 84 | 20 | 27 | 35 | 41 | 47 | 52 | 55 |
| 96 | 18 | 24 | 30 | 36 | 41 | 45 | 50 |
| 108 | 16 | 21 | 27 | 32 | 37 | 40 | 44 |
| 120 | 14 | 19 | 24 | 29 | 33 | 36 | 40 |
| 132 | 13 | 17 | 22 | 26 | 30 | 33 | 36 |
| 144 | 12 | 16 | 20 | 24 | 27 | 30 | 33 |
| 156 | | 14 | 18 | 22 | 25 | 28 | 30 |
| 168 | | 13 | 17 | 20 | 23 | 26 | 28 |
| 180 | | | 16 | 19 | 22 | 24 | 26 |

U.S. Army Corps of Engineers

Notes:

1. Structural-plate-aluminum-alloy pipe will conform to the requirements of Federal Specification WW-P-402.
2. Soil conditions, trench width and bedding conditions vary widely throughout varying climatic and geographical areas.
3. Calculations to determine maximum cover should be made for all individual pipe and culvert installations underlying roads, streets and open storage areas subject to H-20 live loads. Cooper E-80 railway loadings should be independently made.
4. Cover depths are measured from the bottom of the subbase of pavements, or the top of unsurfaced areas, to top of pipe.
5. Calculations to determine maximum cover for Cooper E-80 railway loadings are measured from the bottom of the tie to the top of the pipe.
6. The number in the class designation for asbestos-cement pipe is the minimum 3-edge test load to produce failure in pounds per linear foot. It is independent of pipe diameter. An equivalent to the D-load can be obtained by dividing the number in the class designation by the internal pipe diameter in feet.
7. If pipe produced by a manufacturer exceeds the strength requirements established by indicated standards then cover depths may be adjusted accordingly.
8. See table C-9 for suggested minimum cover requirements.

Table C-6. Suggested Maximum Cover Requirements for Corrugated Steel Pipe, 125-mm Span, 25-mm Deep Corrugations
H-20 Highway Loading

| Diameter, inches | Maximum cover above top of pipe, feet | | | | |
|---------------------|---------------------------------------|------|------|------|------|
| | Helical—thickness, inches | | | | |
| | .064 | .079 | .109 | .138 | .168 |
| 48 | 54 | 68 | 95 | 122 | 132 |
| 54 | 48 | 60 | 84 | 109 | 117 |
| 60 | 43 | 54 | 76 | 98 | 107 |
| 66 | 39 | 49 | 69 | 89 | 101 |
| 72 | 36 | 45 | 63 | 81 | 96 |
| 78 | 33 | 41 | 58 | 75 | 92 |
| 84 | 31 | 38 | 54 | 70 | 85 |
| 90 | 29 | 36 | 50 | 65 | 80 |
| 96 | | 34 | 47 | 61 | 75 |
| 102 | | 32 | 44 | 57 | 70 |
| 108 | | | 42 | 54 | 66 |
| 114 | | | 40 | 51 | 63 |
| 120 | | | 38 | 49 | 60 |

U.S. Army Corps of Engineers

Notes:

1. Corrugated steel pipe will conform to the requirements of Federal Specification WW-P-405.
2. The suggested maximum heights of cover shown in the table are calculated on the basis of the current AASHTO Standard Specifications for Highway Bridges and are based on circular pipe.
3. Soil conditions, trench width and bedding conditions vary widely throughout varying climatic and geographical areas.
4. Calculations to determine maximum cover should be made for all individual pipe and culvert installations underlying roads, streets and open storage areas subject to H-20 live loads. Cooper E-80 railway loadings should be independently made.
5. Cover depths are measured from the bottom of the subbase of pavements, or the top of unsurfaced areas, to top of pipe.
6. Calculations to determine maximum cover for Cooper E-80 railway loadings are measured from the bottom of the tie to the top of the pipe.
7. If pipe produced by a manufacturer exceeds the strength requirements established by indicated standards then cover depths may be adjusted accordingly.
8. See table C-9 for suggested minimum cover requirements.

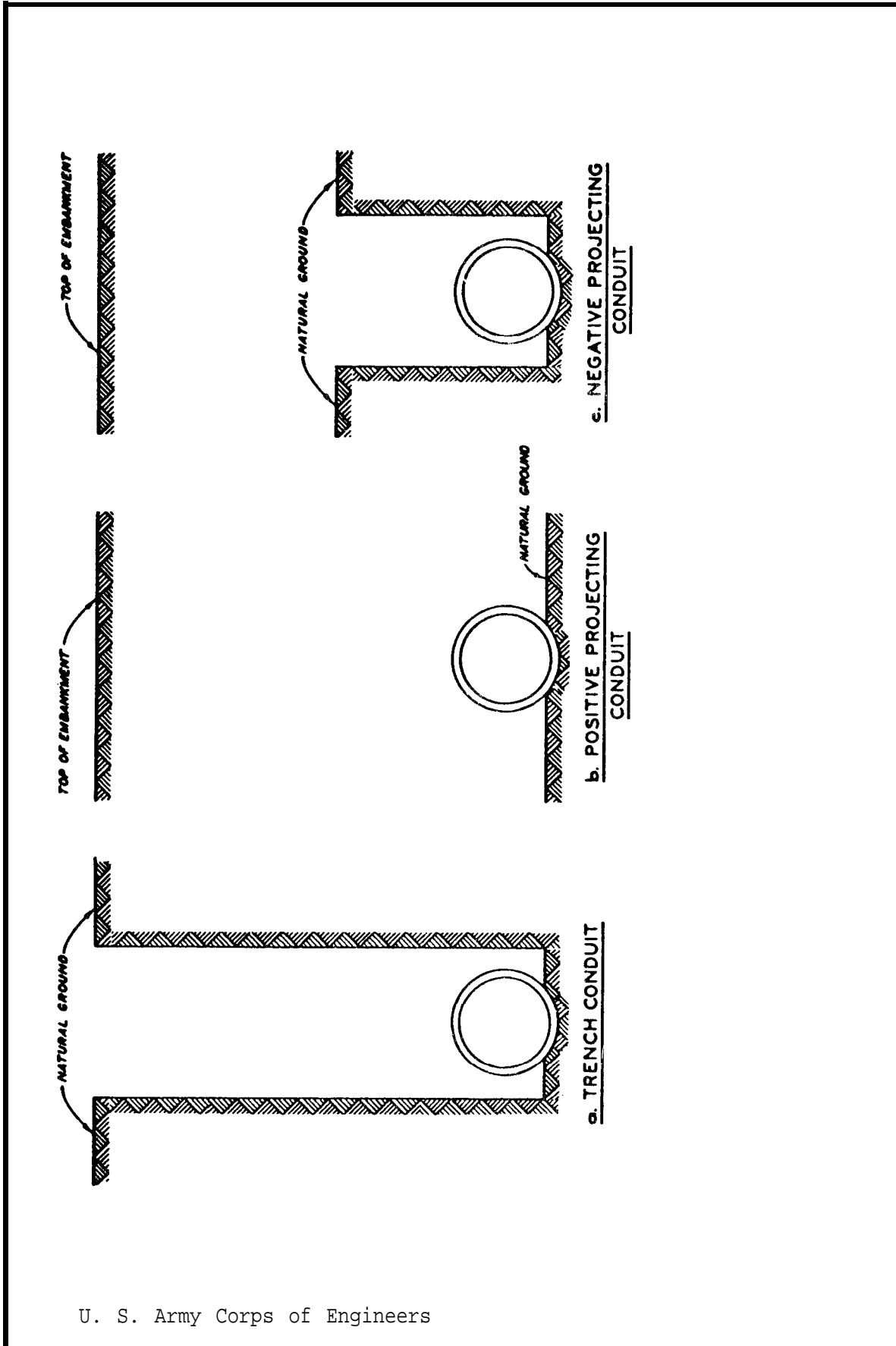
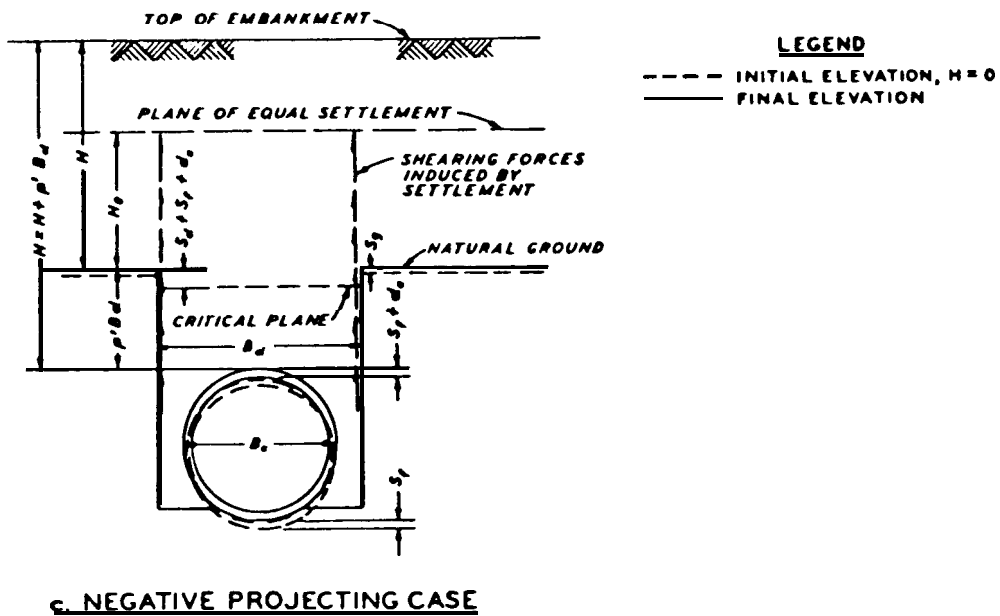
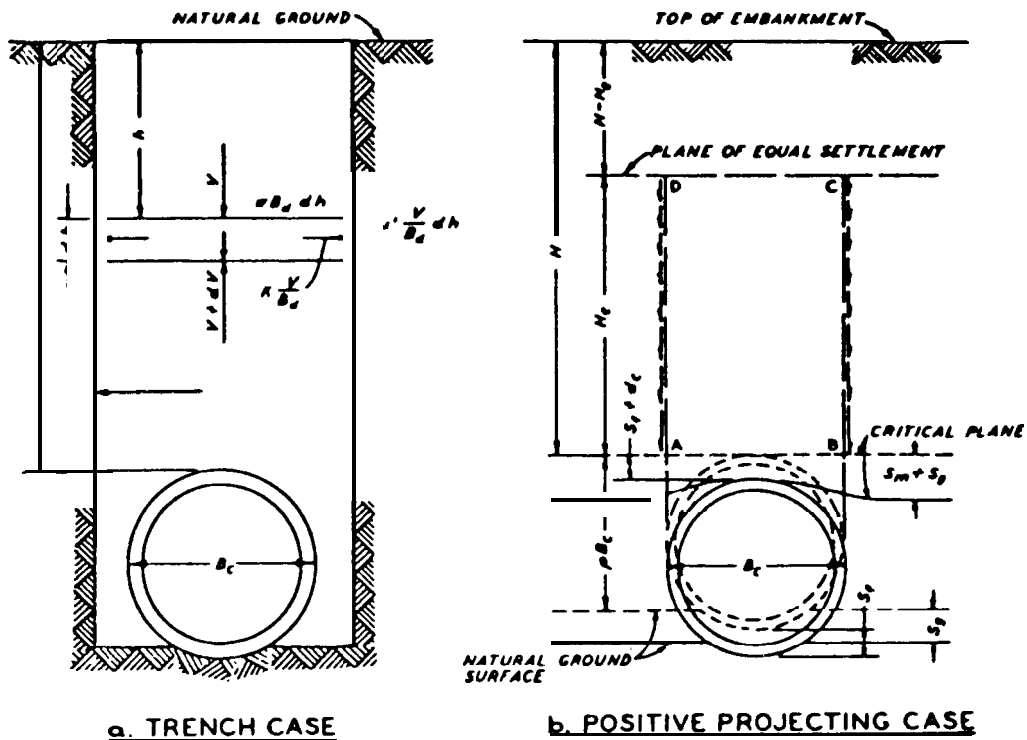

Figure C-1. Three main classes of conduits.



U. S. Army Corps of Engineers

RD64733D

Figure C-2. Free-body conduit diagrams.

Notes:

For Class B and C beddings, subgrades should be excavated or over excavated, if necessary, so a uniform foundation free of protruding rocks may be provided. Special care may be necessary with Class A or other unyielding foundations to cushion pipe from shock when blasting can be anticipated in the area.

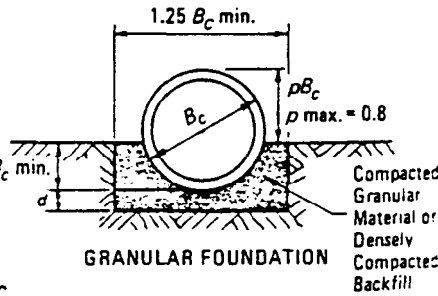
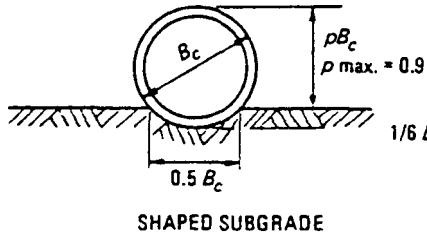
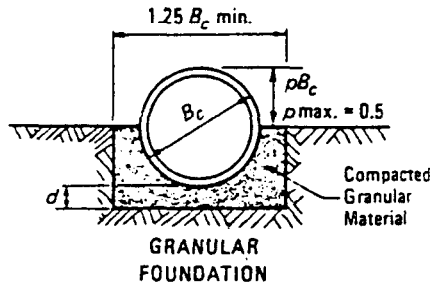
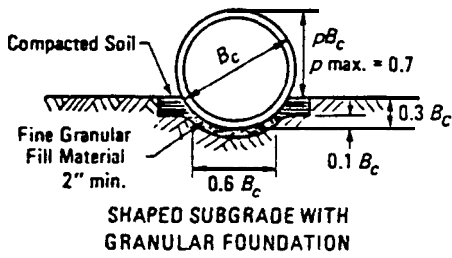
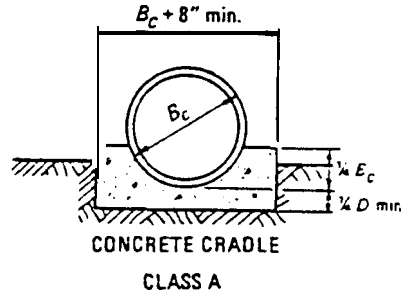

CLASS C

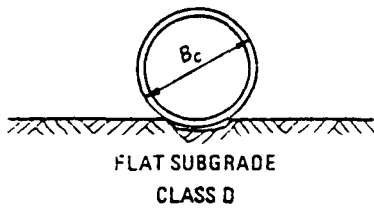

Depth of Bedding Material Below Pipe

| D | d (min.) |
|---------------|------------|
| 27" & smaller | 3" |
| 30" to 60" | 4" |
| 66" & larger | 6" |

Legend

- B_c = outside diameter
- H = backfill cover above top of pipe
- D = inside diameter
- d = depth of bedding material below pipe

Figure C-3. Embankment Beddings Circular Pipe

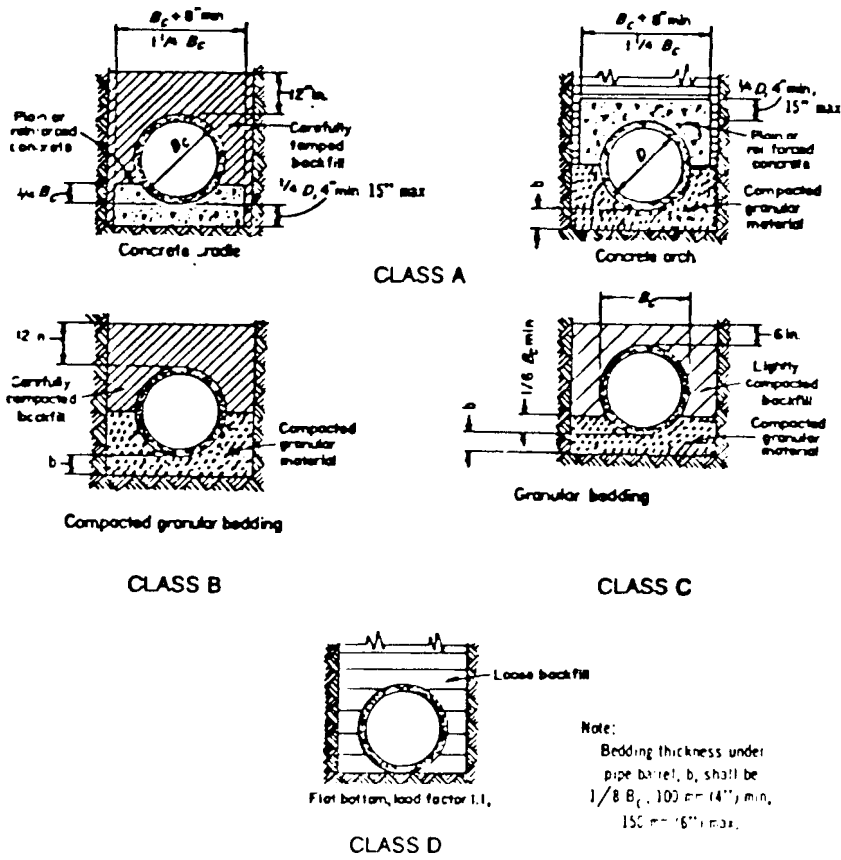
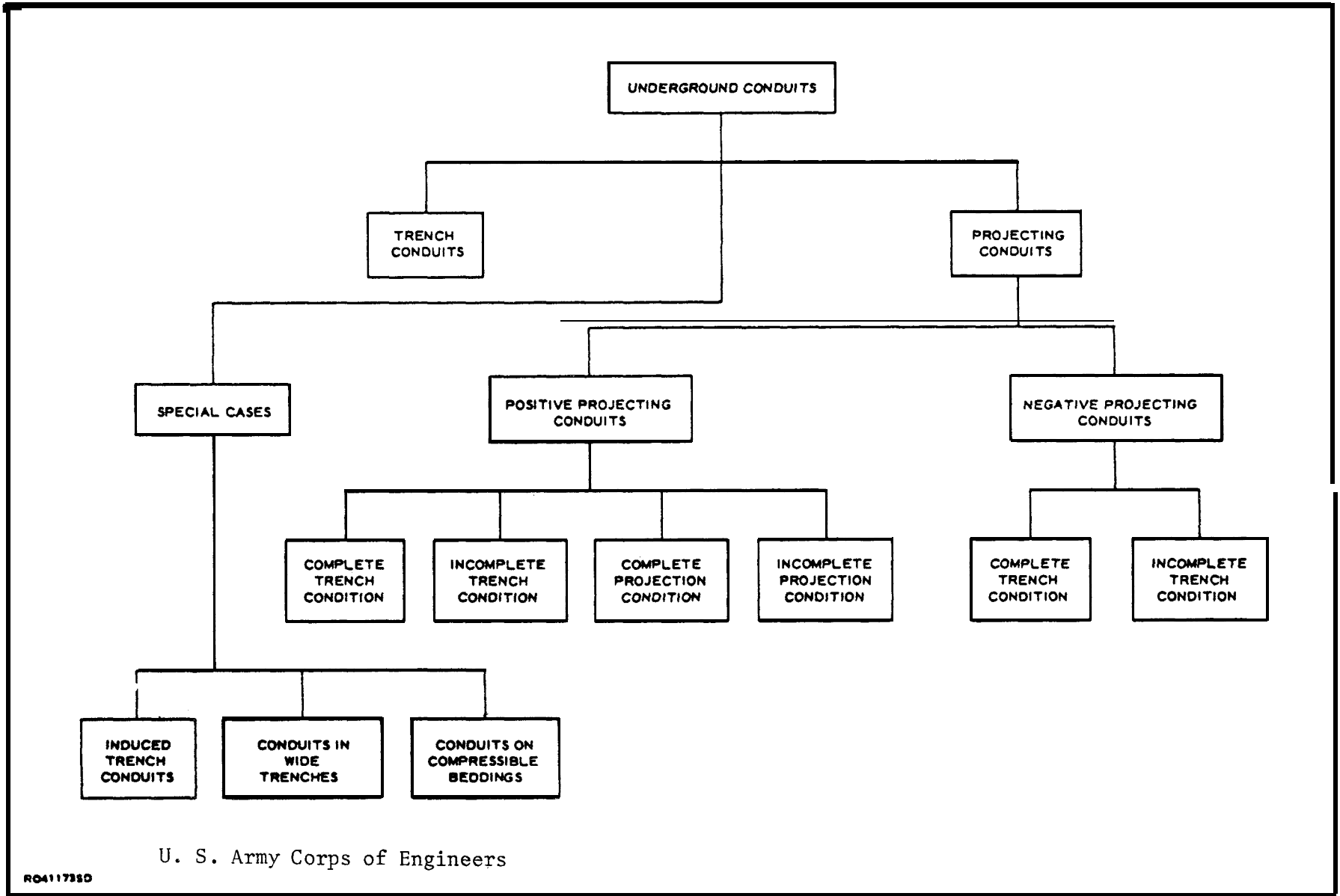

Figure C-4. Trench Beddings for Circular Pipe



U. S. Army Corps of Engineers

RD41173SD

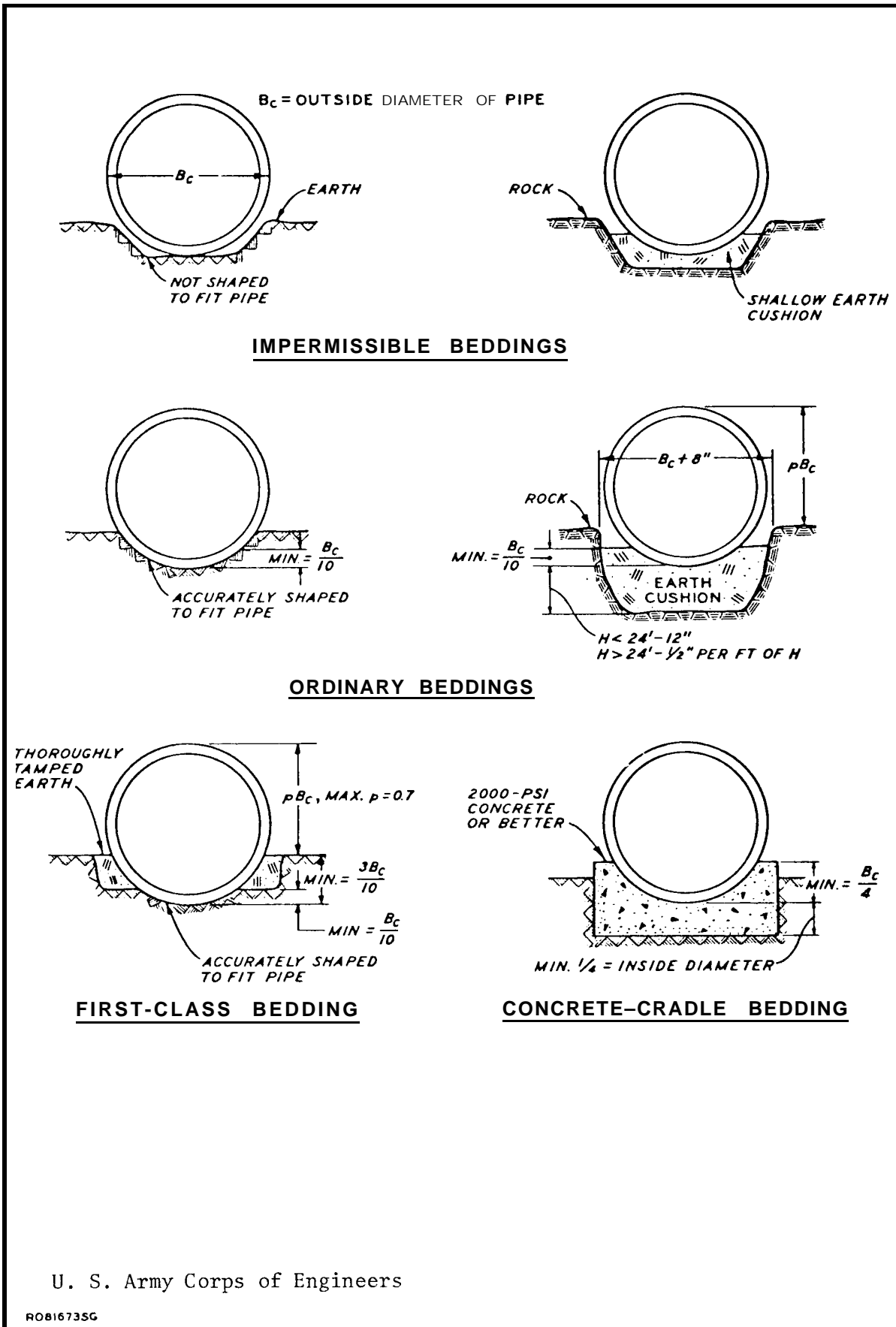
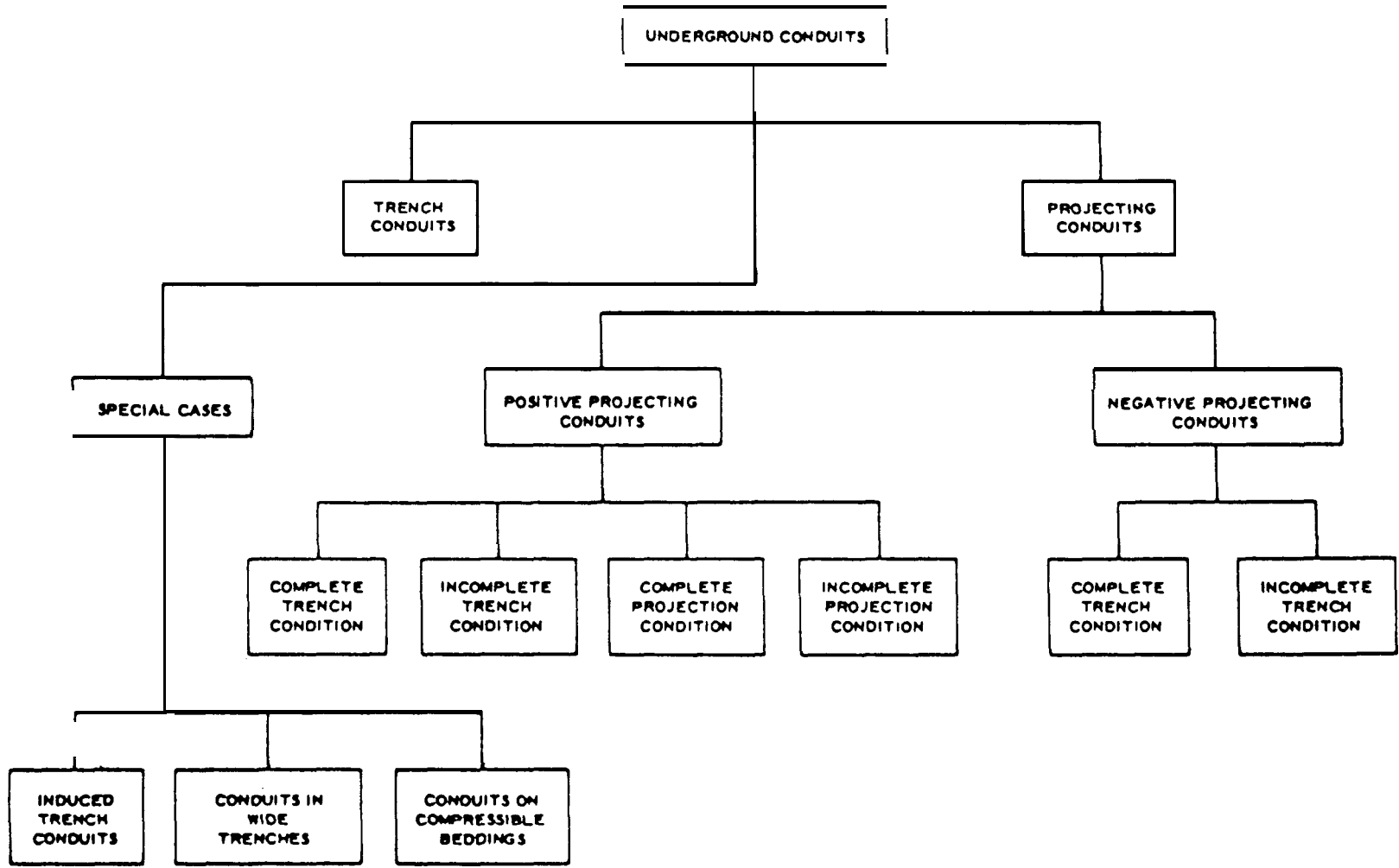

Figure C-5. Installation conditions which influence loads on underground conduits.

U. S. Army Corps of Engineers

RO816735G



U. S. Army Corps of Engineers

NO4117330

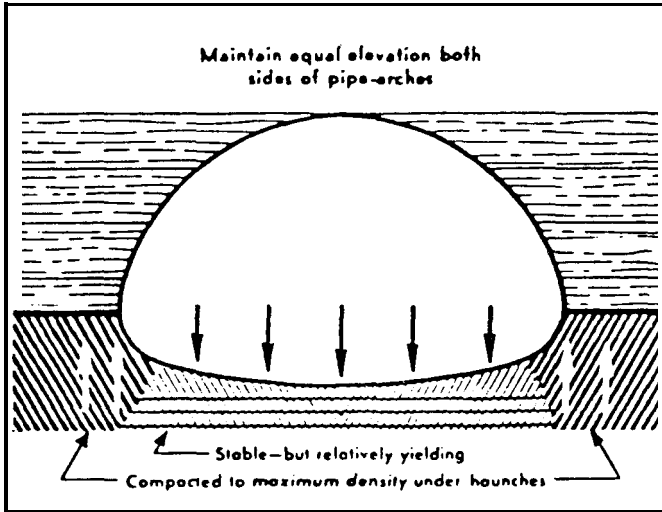

Recommended backfilling practice for pipe-arch.

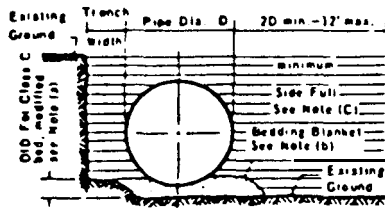

(A) PIPE INSTALLATION AND BEDDING

NOTES

- (a) For structural plate pipe, the length of bedding need not exceed width of bottom plate.
- (b) Bedding blanket of loose granular fill roughly shaped to fit bottom of pipe. Minimum thickness before placing pipe shall be as follows:
 1" for 4" deep corrugation
 2" for 1" deep corrugation
 3" for 2" deep corrugation
- (c) Side fill to be compacted in 6" layers to density specified for adjacent embankment not less than 95% Proctor Density.

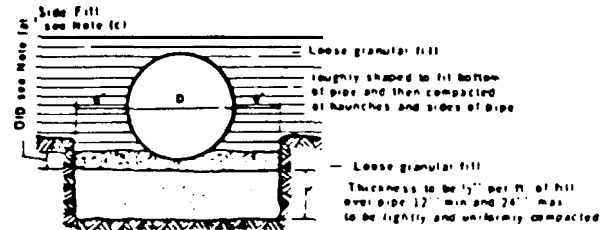

(B) ROCK

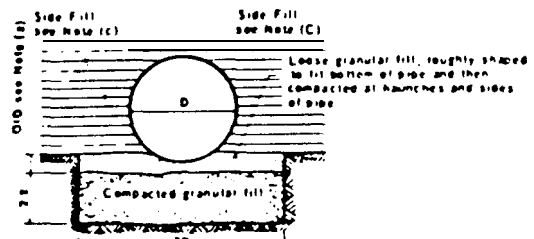

(C) FOUNDATION STABILIZATION FOR SMALL DIAMETER STRUCTURES

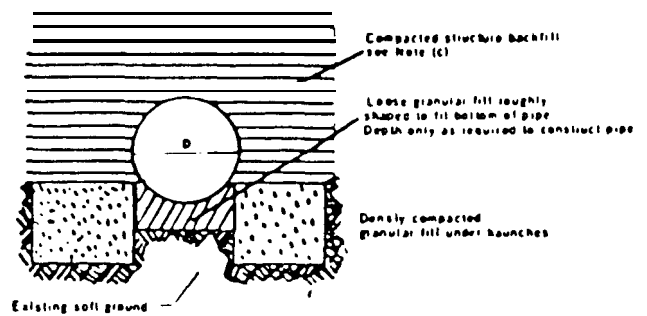

(D) FOUNDATION STABILIZATION FOR LARGE-DIAMETER STRUCTURES

Figure C-5. Flexible Pipe Bedding and Installation

Table C-7. Suggested Maximum Cover Requirements for Structural Plate Steel Pipe, 6-Inch Span, 2-Inch Deep Corrugations

| H-20 HIGHWAY LOADING | | | | | | | |
|---------------------------------------|-------------------|------|------|------|------|------|------|
| MAXIMUM COVER ABOVE TOP OF PIPE, FEET | | | | | | | |
| DIAMETER, FEET | THICKNESS, INCHES | | | | | | |
| | .109 | .138 | .168 | .188 | .218 | .249 | .280 |
| 5.0 | 46 | 68 | 90 | 103 | 124 | 146 | 160 |
| 5.5 | 42 | 62 | 81 | 93 | 113 | 133 | 145 |
| 6.0 | 38 | 57 | 75 | 86 | 103 | 122 | 133 |
| 6.5 | 35 | 52 | 69 | 79 | 95 | 112 | 123 |
| 7.0 | 33 | 49 | 64 | 73 | 88 | 104 | 114 |
| 7.5 | 31 | 45 | 60 | 68 | 82 | 97 | 106 |
| 8.0 | 29 | 43 | 56 | 64 | 77 | 91 | 100 |
| 8.5 | 27 | 40 | 52 | 60 | 73 | 86 | 94 |
| 9.0 | 25 | 38 | 50 | 57 | 69 | 81 | 88 |
| 9.5 | 24 | 36 | 47 | 54 | 65 | 77 | 84 |
| 10.0 | 23 | 34 | 45 | 51 | 62 | 73 | 80 |
| 10.5 | 22 | 32 | 42 | 49 | 59 | 69 | 76 |
| 11.0 | 21 | 31 | 40 | 46 | 56 | 66 | 72 |
| 11.5 | 20 | 29 | 39 | 44 | 54 | 63 | 69 |
| 12.0 | 19 | 28 | 37 | 43 | 51 | 61 | 66 |
| 12.5 | 18 | 27 | 36 | 41 | 49 | 58 | 64 |
| 13.0 | 17 | 26 | 34 | 39 | 47 | 56 | 61 |
| 13.5 | 17 | 25 | 33 | 38 | 46 | 54 | 59 |
| 14.0 | 16 | 24 | 32 | 36 | 44 | 52 | 57 |
| 14.5 | 16 | 23 | 31 | 35 | 42 | 50 | 55 |
| 15.0 | 15 | 22 | 30 | 34 | 41 | 48 | 53 |
| 15.5 | 15 | 22 | 29 | 33 | 40 | 47 | 51 |
| 16.0 | | 21 | 28 | 32 | 38 | 45 | 50 |
| 16.5 | | 20 | 27 | 31 | 37 | 44 | 48 |
| 17.0 | | 20 | 26 | 30 | 36 | 43 | 47 |
| 17.5 | | 19 | 25 | 29 | 35 | 41 | 45 |
| 18.0 | | | 25 | 28 | 34 | 40 | 44 |
| 18.5 | | | 24 | 27 | 33 | 39 | 43 |
| 19.0 | | | 23 | 27 | 32 | 38 | 42 |
| 19.5 | | | 23 | 26 | 31 | 37 | 41 |
| 20.0 | | | | 25 | 31 | 36 | 40 |
| 20.5 | | | | 25 | 30 | 35 | 39 |
| 21.0 | | | | | 29 | 34 | 38 |
| 21.5 | | | | | 28 | 34 | 37 |
| 22.0 | | | | | 28 | 33 | 36 |
| 22.5 | | | | | 27 | 32 | 35 |
| 23.0 | | | | | | 31 | 34 |
| 23.5 | | | | | | 31 | 34 |
| 24.0 | | | | | | 30 | 33 |
| 24.5 | | | | | | | 32 |
| 25.0 | | | | | | | 32 |
| 25.5 | | | | | | | 31 |

1. Corrugated steel pipe will conform to the requirements of Federal Specification W-P-405.
2. The suggested maximum heights of cover shown in the table are calculated on the basis of the current AASHTO Standard Specifications for Highway Bridges and are based on circular pipe.
3. Soil conditions, trench width and bedding conditions vary widely throughout varying climatic and geographical areas. --
4. Calculations to determine maximum cover should be made for all individual pipe and culvert installations underlying roads, streets and open storage areas subject to H-20 live loads. Cooper E-80 railway loadings should be independently made.
5. Cover depths are measured from the bottom of the subbase of pavements, or the top of unsurfaced areas, to top of pipe.
6. Calculations to determine maximum cover for Cooper E-80 railway loadings are measured from the bottom of the tie to the top of the pipe.
7. If pipe produced by a manufacturer exceeds the strength requirements established by indicated standards then cover depths may be adjusted accordingly.
8. See table C-9 for suggested minimum cover requirements.

Table C-8. Suggested Maximum Cover Requirements for Corrugated Steel Pipe, 3-Inch Span, 1-Inch Corrugations

| H-20 HIGHWAY LOADING | | | | | | | | | | |
|---------------------------------------|------------------------------------|------|------|------|------|------------------------------------|------|------|------|------|
| MAXIMUM COVER ABOVE TOP OF PIPE, FEET | | | | | | | | | | |
| DIAMETER, INCHES | <u>RIVETED - THICKNESS, INCHES</u> | | | | | <u>HELICAL - THICKNESS, INCHES</u> | | | | |
| | .064 | .079 | .109 | .138 | .168 | .064 | .079 | .109 | .138 | .168 |
| 36 | 53 | 66 | 98 | 117 | 130 | 81 | 101 | 142 | 178 | 201 |
| 42 | 45 | 56 | 84 | 101 | 112 | 69 | 87 | 122 | 142 | 157 |
| 48 | 39 | 49 | 73 | 88 | 98 | 61 | 76 | 107 | 122 | 132 |
| 54 | 35 | 44 | 65 | 78 | 87 | 54 | 67 | 95 | 110 | 117 |
| 60 | 31 | 39 | 58 | 70 | 78 | 48 | 61 | 85 | 102 | 107 |
| 66 | 28 | 36 | 53 | 64 | 71 | 44 | 55 | 77 | 97 | 101 |
| 72 | 26 | 33 | 49 | 58 | 65 | 40 | 50 | 71 | 92 | 96 |
| 78 | 24 | 30 | 45 | 54 | 60 | 37 | 47 | 65 | 84 | 93 |
| 84 | 22 | 28 | 42 | 50 | 56 | 34 | 43 | 61 | 78 | 91 |
| 90 | 21 | 26 | 39 | 47 | 52 | 32 | 40 | 57 | 73 | 89 |
| 96 | | 24 | 36 | 44 | 49 | | 38 | 53 | 69 | 84 |
| 102 | | 23 | 34 | 41 | 46 | | 35 | 50 | 64 | 79 |
| 108 | | | 32 | 39 | 43 | | | 47 | 61 | 75 |
| 114 | | | 30 | 37 | 41 | | | 45 | 58 | 71 |
| 120 | | | 29 | 35 | 39 | | | 42 | 55 | 67 |

U. S. Army Corps of Engineers

Notes:

1. Corrugated steel pipe will conform to there requirements of Federal Specification WW-P-405.
2. The suggested maximum heights of cover shown in the table are calculated on the basis of the current AASHTO Standard Specifications for Highway Bridges and are based on circular pipe.
3. Soil conditions, trench width and bedding conditions vary widely throughout varying climatic and geographical areas.
4. Calculations to determine maximum cover should be made for all individual pipe and culvert installations underlying roads, streets and open storage areas subject to H-20 live loads. Cooper E-80 railway loadings should be independently made.
5. Cover depths are measured from the bottom of the subbase of pavements, or the top of unsurfaced areas, to top of pipe.
6. Calculations to determine maximum cover for Cooper E-80 railway loadings are measured from the bottom of the tie to the top of the pipe.
7. If pipe produced by a manufacturer exceeds the strength requirements established by indicated standards then cover depths may be adjusted accordingly.
8. See table C-9 for suggested minimum cover requirements.

unusual installation conditions, a detailed analysis will be made so that ample safeguards for the pipe will be provided with regard to strength and resistance to deflection due to loads. Determinations for deflections of flexible pipe should be made if necessary. For heavy live loads and heavy loads due to considerable depth of cover, it is desirable that a selected material, preferably bank-run gravel or crushed stone where economically available, be used for backfill adjacent to the pipe. Table C-9 suggests guidelines for minimum cover to protect the pipe during construction and the minimum finished height of cover.

C-10. Bedding of pipe (culverts and storm drains). The contact between a pipe and the foundation on which it rests is the pipe bedding. It has an important influence on the supporting strength of the pipe. For drainpipes at military installations, the method of bedding shown in figure C-3 is generally satisfactory for both trench and positive projecting (embankment) installations. Some designs standardize and classify various types of bedding in regard to the shaping of the founda-

tion, use of granular material, use of concrete, and similar special requirements. Although such refinement is not considered necessary, at least for standardized cover requirements, select, fine granular material can be used as an aid in shaping the bedding, particularly where foundation conditions are difficult. Also, where economically available, granular materials can be used to good advantage for backfill adjacent to the pipe. When culverts or storm drains are to be installed in unstable or yielding soils, under great heights of fill, or where pipe will be subjected to very heavy live loads, a method of bedding can be used in which the pipe is set in plain or reinforced concrete of suitable thickness extending upward on each side of the pipe. In some instances, the pipe may be totally encased in concrete or concrete may be placed along the side and over the top of the pipe (top or arch encasement) after proper bedding and partial backfilling. Pipe manufacturers will be helpful in recommending type and specific requirements for encased, partially encased, or specially reinforced pipe in connection with design for complex conditions.

Table C-9. Suggested Guidelines for Minimum Cover

| H-20 Highway Loading | | | |
|--|-------------------------------|---|--|
| | Minimum Cover to Protect Pipe | | Minimum Finished Height of Cover (From Bottom of Subbase, to Top of Pipe) |
| | Pipe Diameter, in. | Height of Cover During Construction ft. | |
| Asbestos-Cement Pipe | 12" to 42" | Diameter/2 or 3.0' whichever is greater | Diameter/2 or 2.0' whichever is greater |
| Concrete Pipe Reinforced | 12" to 108" | Diameter/2 or 3.0' whichever is greater | Diameter/2 or 2.0' whichever is greater |
| Non-Reinforced | 12" to 36" | Diameter/2 or 3.0' whichever is greater | Diameter/2 or 3.0' whichever is greater |
| Corrugated Aluminum Pipe 2-2/3" x 1/2" | 12" to 24" 30" and over | 1.5' Diameter | Diameter/2 or 1.0' whichever is greater Diameter/2 |
| Corrugated Steel Pipe 3" x 1" | 12" to 30" 36" and over | 1.5' Diameter | Diameter/2 or 1.0' whichever is greater Diameter/2 |
| Structural Plate Aluminum Alloy Pipe 9" x 2-1/2" | 72" and over | Diameter/2 | Diameter/4 |
| Structural Plate Steel 6" x 2" | 60" and over | Diameter/2 | Diameter/4 |

U. S. Army Corps of Engineers

Notes:

1. All values shown above are for average conditions and are to be reconsidered as guidelines only.
2. Calculations should be made for minimum cover for all individual pipe installations for pipe underlying roads, streets and open storage areas subject to H-20 live loads.
3. Calculations for minimum cover for all individual pipe installations should be separately made for all Cooper E-80 railroad live loading.
4. In seasonal frost areas, minimum pipe cover must meet requirements of table 2-3 of TM 5-820-3 for protection of storm drains.
5. Pipe placed under rigid pavement will have minimum cover from the bottom of the subbase to top of pipe of 1.0 ft. for pipe up to 60 inches and greater than 1.0 ft. for sizes above 60 inches if calculations so indicate.
6. Trench widths depend upon varying conditions of construction but may be as wide as is consistent with space required to install the pipe and as deep as can be managed from practical construction methods.
7. Non-reinforced concrete pipe is available in sizes up to 36 inches.
8. See tables C-1 through C-8 for suggested maximum cover requirements.

APPENDIX D

NOTATION

| | |
|----------------|---|
| A | Drainage area, acres, total area of clear opening, or cross-sectional area of flow, ft ² . |
| AHW | Allowable headwater depth, ft. |
| B | Width, ft. |
| C | Coefficient. |
| D | Height of culvert barrel, ft. |
| d | Depth or thickness of grate, ft. |
| d _c | Critical depth, ft. |
| F | Infiltration rate, in/hr. |
| g | Acceleration due to gravity, ft/sec ² . |
| H | Depth of water, ft. |
| H _f | Headloss due to friction, ft. |
| HW | Headwater, ft. |
| h _o | Distance from culvert invert at the outlet to the control elevation, ft. |
| I | Rainfall intensity, in/hr. |
| i | Hydraulic gradient. |
| K | Constant. |
| K _e | Coefficient. |
| k | Coefficient of permeability. |
| L | Length of slot or gross perimeter of grate opening, or length, ft. |
| L ₁ | Adjusted length, ft. |
| L _s | Length of spiral, ft. (nonsuperelevated channel). |
| L _t | Length of spiral, ft. (superelevated channels). |
| n | Manning's roughness coefficient. |
| Q | Discharge or peak rate of runoff, cfs. |
| R | Hydraulic radius, ft. |
| R _c | Radius of curvature center line of channel, ft. |
| S | Slope of energy gradient, ft/ft. |
| S ₀ | Slope of flow line, ft/ft. |
| T | Top width at water surface, ft. |
| TW | Tailwater, ft. |
| V | Mean velocity of flow, ft/sec. |
| v | Discharge velocity in Darcy's law, ft/sec. |
| γ | Depth of water, ft. |

APPENDIX E

BIBLIOGRAPHY

- A Policy on Design of Urban Highways and Arterial Streets*, American Association of State Highway Officials, 1973.
- Baker, R. F., Byrd, L. G., and Mickle, D. E., *Handbook of Highway Engineering*, New York: Van Nostrand-Reinholde, 1974.
- Concrete Pipe Design Manual, American Concrete Pipe Association, 1974.
- Handbook of Drainage and Construction Products, Armco Drainage and Metal Products, Inc., Ohio, 1967.
- Handbook of Steel Drainage and Highway Construction Products, American Iron and Steel Institute, New York, 1971.
- King, H. W., and Brater, E. E., *Handbook of Hydraulics*, McGraw-Hill Book Company, Inc., New York, N.Y., 1963.
- Morris, H. M., and Wiggert, J. M., *Applied Hydraulics in Engineering*, 2nd Edition, New York: Ronald Press Company, 1971.
- Paguette, R. J., Ashford, N., and Wright, P. H., *Transportation Engineering*, New York: Ronald Press Company, 1972.
- Ritter, L. J., Jr., and Paquette, R. J., *Highway Engineering*, New York: Ronald Press Company, 1967.
- Sewer Manual For Corrugated Steel Pipe, National Corrugated Steel Pipe Association, Illinois, 1978.
- Silberman, E., and Dahlin, W. Q., *Friction Factors for Helical Corrugated Aluminum Pipe*, Project Report No. 112, University of Minnesota, St. Anthony Falls Hydraulic Laboratory, 1969.
- Stevens, M. A., Simmons, D. E., and Watts, F. J., *Riprapped Basins for Culvert Outlets*, Highway Research Record, No. 373, 1971.
- U.S. Department of Agriculture, *Friction Factors for Helical Corrugated Pipe*, by C. E. Rice, ARS 41-119, 1966.
- U.S. Army Engineer Waterways Experiment Station, *Erosion and Riprap Requirements at Culvert and Stem-Drain Outlets*, by J. P. Bohan, Research Report H-70-2, 1970.
- U.S. Army Engineer Waterways Experiment Station, *Evaluation of Three Energy Dissipators for Stem-Drain Outlets*, by J. L. Grace and G. A. Pickering, Research Report H-71-1, 1971.
- U.S. Army Engineer Waterways Experiment Station, *Practical Guidance for Estimating and Controlling Erosion at Culvert Outlets*, by B. P. Fletcher and J. L. Grace, Jr., Miscellaneous Paper H-72-5, 1972.
- U.S. Department of the Interior, Bureau of Reclamation, *Hydraulic Design of Stilling Basin for Pipe or Channel Outlets*, by G. L. Beickley, Research Report No. 24, 1971.
- U.S. Department of Transportation, Federal Highway Administration, *Hydraulic Design of Improved Inlets for Culverts*, Hydraulic Engineering Circular No. 13, August 1972.

Viessman, W., Jr., Knapp, J. W., Lewis, G. L., and Harbaugh, T. E., *Introduction to Hydrology*, 2nd Edition, New York: TEP, 1977.

Yen, B. C., and Ying-Chang Lieu, *Hydraulic Resistance in Alluvial Channels*, Research Report No. 22, University of Illinois Water Research Center, Urbana, Illinois, 1969.

The proponent agency of this publication is the Office of the Chief of Engineers, United States Army. Users are invited to send comments and suggested improvements on DA Form 2028 (Recommended Changes to Publications and Blank Forms) direct to HQDA (DAEN-ECE-G), WASH DC 20314.

By Order of the Secretaries of the Army and the Air Force:

JOHN A. WICKHAM, JR.
General, United States Army
Chief of Staff

Official:

ROBERT M. JOYCE
Major General, United States Army
The Adjutant General

CHARLES A. GABRIEL, General, USAF
Chief of Staff

Official:

JAMES H. DELANEY, Colonel, USAF
Director of Administration

Distribution:

Army: To be distributed in accordance with DA Form 12-34B, requirements for TM 5-800 Series: Engineering and Design for Real Property Facilities.

Air Force: F